



Product	Nominal torque	Self-holding torque	Nominal rated speed
PSE 3210-14	10 Nm	5 Nm	30 rpm
PSE 3218-14	18 Nm	9 Nm	17 rpm

**Data interfaces**  
CANopen, PROFIBUS DP, DeviceNet, Modbus RTU, Sercos, EtherCAT, PROFINET, EtherNet/IP, POWERLINK, IO-Link

Start-up duration	30 % (basis time 300 s)
Mode of operation	S3
Supply voltage	24 VDC $\pm$ 10 % galvanically separated between control and motor and bus
Nominal current	3.1 A
Power consumption (control unit)	0.1 A
Positioning accuracy absolute measurement of position taken directly at the output shaft	0.9°
Positioning range	250 rotations not subject to mechanical limits
Shock resistance in accordance with IEC/DIN EN 60068-2-27	50 g 11 ms
Vibration resistance in accordance with IEC/DIN EN 60068-2-6	10 .. 55 Hz 1.5 mm/ 55 .. 1 000 Hz 10 g/ 10 .. 2 000 Hz 5 g
Output shaft	14 mm hollow shaft with clamp and feather key
Maximum axial force	20 N
Maximum radial force	40 N
Ambient temperature	0 .. 45 °C
Storage temperature	-10 .. 70 °C
Protection class	IP54
Weight	approx. 1350 g
Certificates	CE, optional: NRTL (UL, CSA, ANSI)

The order key and accessories can be found on p. 18 / 19.

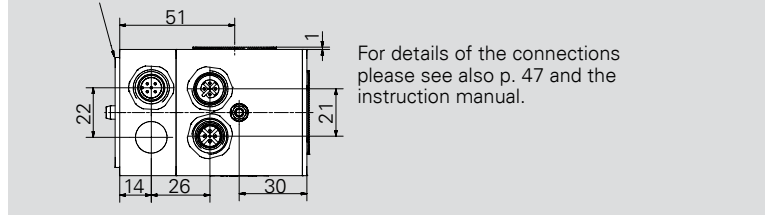
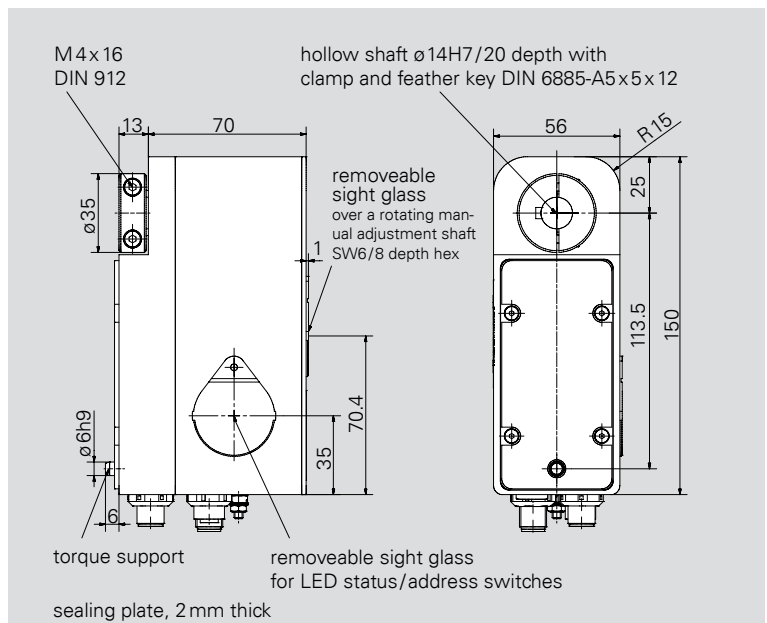

For details of the connections please see also p. 47 and the instruction manual.

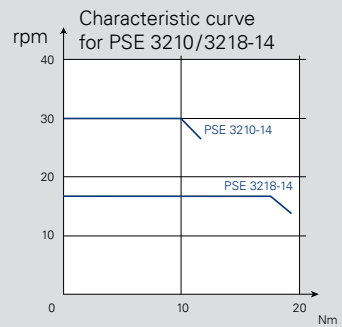

# ORDER KEY PSE/PSS/PSW 3 SERIES

All the positioning systems in the PSE/PSS/PSW 3 series share the same order key.

To provide the best possible overview and to simplify customer documentation, the diverse range of options available for the PSE/PSS/PSW 3 series has been organised in a shared order key.

## Order key

PSE/PSS/PSW:



	Pro-tection class	A Design	B Type	C Bus communication (see p. 7)	D Connections	E Brake (see p. 11)	F NRTL certification
Positioning System <b>Efficient</b> (see p. 20-25) <sup>1)</sup>	IP 54	PSE		CA: CANopen DP: PROFIBUS DP DN: DeviceNet	0: without jog keys T: with jog keys <sup>3)</sup> Y: 1 connector, Y-encoded Z: 1 connector, Y-encoded, with jog keys <sup>3)</sup>		0: without,  only N: with NRTL certification (in accordance with UL, CSA, ANSI and CE)
Positioning System <b>Stainless</b> (see p. 28-31)	IP 65	PSS	30x-8/-14 (V) <sup>2)</sup> 31x-8/-14 (V) <sup>2)</sup> 32x-14 (V) <sup>2)</sup> 33x-14 (V) <sup>2)</sup>	MB: Modbus RTU SE: Sercos EC: EtherCAT PN: PROFINET EI: EtherNet/IP PL: POWERLINK IO: IO-Link		0: without M <sup>4)</sup> : with	
Positioning System <b>Washable</b> (see p. 32-35)	IP 68	PSW					

<sup>1)</sup> You can find the order key for the PSE 34\_-14 on page 26.

<sup>2)</sup> (V) not for PSE

<sup>3)</sup> not for PSW or IO-Link, always via an extra connector

<sup>4)</sup> only with 14 mm output shafts

## Standard equipment (Connections)

- second databus connection always provided (not for IO-Link or Y-encoded connector)
- address switches always provided (also IE-buses, not for IO-Link)

For further information on connections and address settings see also "Overview: bus communication" on p.47.

Form/Type	Torque	Output shaft
horizontal	30	8 = 8 mm hollow shaft
vertical	31	14 = 14 mm hollow shaft
horizontal	32	8V = 8 mm solid shaft <sup>6)</sup>
vertical	33	14V = 14 mm solid shaft <sup>6)</sup>

<sup>5)</sup> only for PSE  
18 Nm: horiz.  
25 Nm: long.

<sup>6)</sup> only for PSS/PSW

Examples of orders provided below.

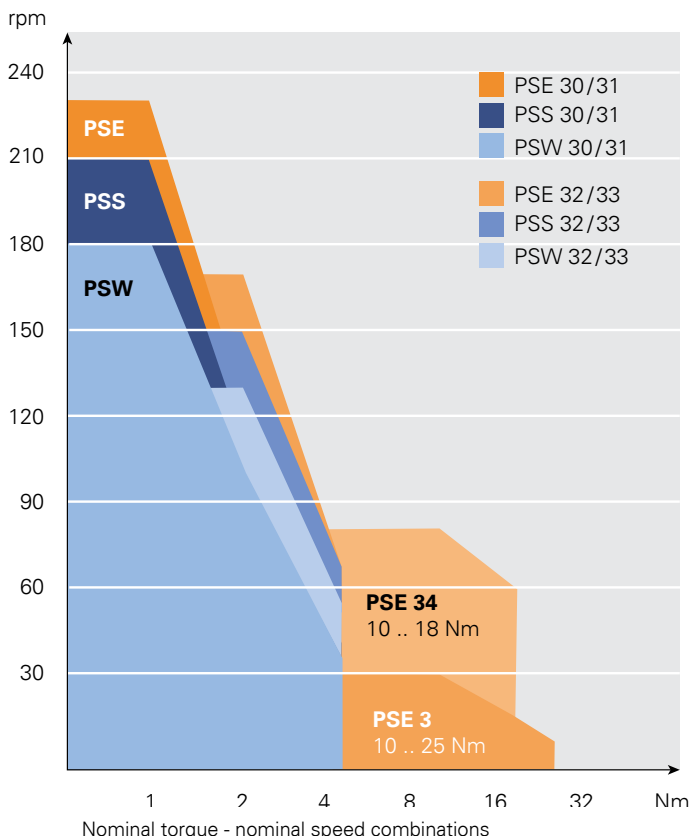

## TORQUES AND SPEEDS

### Example 1

You require the protection class IP54 and a maximum torque of 2 Nm. The speed should be greater than 100 rpm. An 8 mm hollow shaft and longitudinal construction meet the requirements of your application.

Your wish to use EtherNet/IP as the bus and connect the PSE to the control unit using a hybrid connector and hub. You do not require an additional holding brake in your application.

→ PSE 312-8-EI-Y-0-0







### Example 2

IP 68, max. 3 Nm, > 100 rpm, horizontal construction, 14 mm solid circular shaft, IO-Link via a connector, with brake.

→ PSW 325-14V-IO-0-M-0

## ACCESSORIES PSE/PSS/PSW 3 SERIES

The connectors shown here can be used for all three types of device (PSE/PSS/PSW). This ensures that the PSE (IP54) and PSS (IP65) comply with the IP protection classes. We will also be pleased to help you find a suitable mating connector for the PSW (IP68) if necessary – just ask us!

Bus communication	Power supply + databus connector (2x) (for option 0) <sup>1)</sup>	Power supply + databus (2x) + jog key connector <sup>2)</sup> (for option T) <sup>1)</sup>	Cable and connectors for 1-conductor solution <sup>3)</sup> (for option Y or IO) <sup>1)</sup>			
CANopen						
PROFIBUS DP				Connector set: Order no. 9601.0060	Connector set: Order no. 9601.0062	5 m: Order no. 9601.0245 10 m: Order no. 9601.0233 20 m: Order no. 9601.0234
Modbus RTU				Connector set: Order no. 9601.0088	Connector set: Order no. 9601.0090	
DeviceNet						
Sercos				Connector set: Order no. 9601.0112	Jog key box: Order no. 9601.0241	5 m: Order no. 9601.0240 10 m: Order no. 9601.0244
EtherCAT				Hub on request		
PROFINET				Hub on request		
EtherNet/IP				Hub on request		
POWERLINK				Hub on request		
IO-Link <sup>3)</sup>	-	-				
			Connector: Order no. 9601.0107 <sup>3)</sup>			

<sup>1)</sup> see under "D" in the order key <sup>2)</sup> not for PSW <sup>3)</sup> power supply and bus via one cable, without second databus connector

## PSS/PSW: OPTIMUM HYGIENIC DESIGN



Our stainless steel positioning systems follows the **hygienic design** recommendations (construction design, selection and treatment of materials) of the Chair of Apparatus and Plant Design at the Technical University of Munich, Weihenstephan Science Centre.



Screw cap to cover the second bus connection (for PSS/PSW)

**Order no. 9601.0176**

## MODULES AND DESCRIPTION FILES

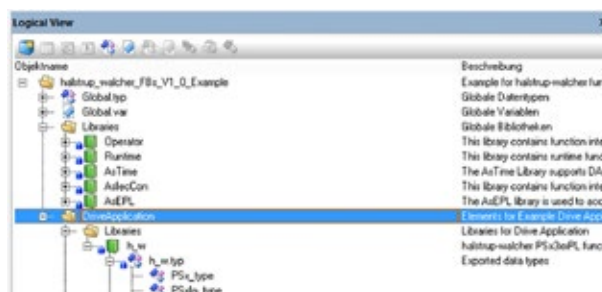

Take advantage of our functional modules or description files for the various buses. You can download the files on our Website:

[www.halstrup-walcher.de/en/software](http://www.halstrup-walcher.de/en/software)