



**Manual**

# **CX2020, CX2030, CX2040**

**Embedded PC**

**Version: 1.8**  
**Date: 2017-12-18**

**BECKHOFF**





# Table of contents

<b>1</b>	<b>Notes on the documentation</b>	<b>5</b>
1.1	Explanation of symbols	6
1.2	Related documents	7
1.3	Documentation issue status	7
<b>2</b>	<b>For your safety</b>	<b>8</b>
2.1	Intended use	8
2.2	Staff qualification	8
2.3	Safety instructions	9
<b>3</b>	<b>Transport and storage</b>	<b>10</b>
<b>4</b>	<b>Product overview</b>	<b>11</b>
4.1	Configuration of the basic CPU module	13
4.2	Name plate	14
4.3	Module overview	15
4.4	Types	16
4.5	Architekture overview	17
<b>5</b>	<b>Description of the interfaces</b>	<b>19</b>
5.1	USB (X100, X101, X102, X103)	19
5.2	Ethernet RJ45 (X000, X001)	20
5.3	DVI-I (X200)	21
5.4	Optional interfaces	22
5.4.1	DVI-D (N010)	22
5.4.2	DisplayPort (N011)	23
5.4.3	RS232 (N030)	24
5.4.4	RS422/RS485 (N031)	25
5.4.5	EtherCAT slave (B110)	26
5.4.6	PROFIBUS (x310)	27
5.4.7	CANopen (x510)	28
5.4.8	PROFINET RT (x930)	29
<b>6</b>	<b>Commissioning</b>	<b>30</b>
6.1	Selecting the appropriate CX2100 power supply unit	30
6.2	Mounting	31
6.2.1	Attaching the power supply unit	31
6.2.2	Installing the bar clips	31
6.2.3	Note the permissible installation positions	32
6.2.4	Attaching on mounting rail	34
6.2.5	CFast card installation and removal	35
6.2.6	Installing passive EtherCAT Terminals	36
6.3	Connecting the power supply	37
6.4	Switching on	39
6.5	Switching off	39
<b>7</b>	<b>Configuration</b>	<b>40</b>
7.1	Windows Embedded Compact 7	40
7.1.1	Scan for new hardware	40
7.2	Windows Embedded Standard 7 P	41
7.2.1	Identification of the Ethernet interfaces (X000, X001)	41
7.2.2	Enabling jumbo frames	42

7.2.3	Set NIC Teaming.....	43
7.2.4	Restoring the Beckhoff real-time driver.....	45
7.3	Windows 10 IoT Enterprise LTSB.....	46
7.3.1	Identification of the Ethernet interfaces (X000, X001) .....	46
7.4	Beckhoff Device Manager.....	47
7.4.1	Starting the Beckhoff Device Manager .....	47
7.4.2	Enabling a remote display.....	48
7.5	TwinCAT .....	49
7.5.1	Tree view.....	49
7.5.2	Searching for target systems .....	50
7.5.3	Adding an Embedded PC .....	52
7.5.4	Configuring EtherCAT cable redundancy. ....	53
7.5.5	Using a hardware watchdog .....	55
<b>8</b>	<b>NOVRAM.....</b>	<b>57</b>
8.1	Use under TwinCAT 3 .....	58
8.1.1	Creating a Retain Handler .....	58
8.1.2	Creating and linking variables.....	60
8.1.3	Note the write speed of the Retain Handler .....	62
8.1.4	Deleting variables under the Retain Handler .....	63
<b>9</b>	<b>UPS (persistent data) .....</b>	<b>64</b>
9.1	Windows write filter .....	65
9.2	Checking the validity of the variables .....	66
9.2.1	SYSTEMINFOTYPE .....	66
9.2.2	PlcAppSystemInfo.....	68
<b>10</b>	<b>Error handling and diagnostics .....</b>	<b>69</b>
10.1	Basic CPU module.....	69
10.1.1	LEDs on the basic CPU module .....	69
10.1.2	Power supply terminal LEDs in K-bus mode.....	69
10.1.3	Power supply terminal LEDs in K-bus mode.....	72
10.2	Faults .....	73
<b>11</b>	<b>Care and maintenance .....</b>	<b>74</b>
11.1	Replace the battery.....	74
11.2	Replace the fan cartridge.....	75
<b>12</b>	<b>Decommissioning.....</b>	<b>77</b>
12.1	Removing cables .....	77
12.2	Dismantling the Embedded PC.....	78
<b>13</b>	<b>Technical data.....</b>	<b>80</b>
<b>14</b>	<b>Appendix .....</b>	<b>82</b>
14.1	Accessories .....	82
14.2	Certifications .....	83
14.3	Support and Service .....	84
	<b>List of tables .....</b>	<b>85</b>
	<b>List of figures.....</b>	<b>87</b>

# 1 Notes on the documentation

This description is only intended for the use of trained specialists in control and automation engineering who are familiar with the applicable national standards.

It is essential that the documentation and the following notes and explanations are followed when installing and commissioning the components.

It is the duty of the technical personnel to use the documentation published at the respective time of each installation and commissioning.

The responsible staff must ensure that the application or use of the products described satisfy all the requirements for safety, including all the relevant laws, regulations, guidelines and standards.

## Disclaimer

The documentation has been prepared with care. The products described are, however, constantly under development.

We reserve the right to revise and change the documentation at any time and without prior announcement.

No claims for the modification of products that have already been supplied may be made on the basis of the data, diagrams and descriptions in this documentation.

## Trademarks

Beckhoff®, TwinCAT®, EtherCAT®, Safety over EtherCAT®, TwinSAFE®, XFC® and XTS® are registered trademarks of and licensed by Beckhoff Automation GmbH.

Other designations used in this publication may be trademarks whose use by third parties for their own purposes could violate the rights of the owners.

## Patent Pending

The EtherCAT Technology is covered, including but not limited to the following patent applications and patents:

EP1590927, EP1789857, DE102004044764, DE102007017835

with corresponding applications or registrations in various other countries.

The TwinCAT Technology is covered, including but not limited to the following patent applications and patents:

EP0851348, US6167425 with corresponding applications or registrations in various other countries.



EtherCAT® is registered trademark and patented technology, licensed by Beckhoff Automation GmbH, Germany

## Copyright

© Beckhoff Automation GmbH & Co. KG, Germany.



The reproduction, distribution and utilization of this document as well as the communication of its contents to others without express authorization are prohibited.

Offenders will be held liable for the payment of damages. All rights reserved in the event of the grant of a patent, utility model or design.

## 1.1 Explanation of symbols

The following symbols with corresponding warnings or explanatory text are used in the documentation. Read and follow the warnings.

### Symbols that warn of personal injury:

 <b>DANGER</b>	<b>Serious risk of injury</b> Note this warning. Hazard with high risk of death or serious injury.
 <b>WARNING</b>	<b>Risk of injury</b> Note this warning. Hazard with medium risk of death or serious injury.
 <b>CAUTION</b>	<b>Personal injuries</b> Note this warning. Hazard with a low degree of risk, which could lead to minor or moderate injury.

### Symbols that warn of damage to property or equipment:

 <b>Attention</b>	<b>Damage to the devices or environment</b> Note this warning. Risk of damage to the environment and equipment.
---	--

### Symbols indicating further information or tips:

 <b>Note</b>	<b>Tip or pointer</b> This symbol indicates information that contributes to better understanding.
--	--

## 1.2 Related documents

This documentation considers and describes material that is relevant for the Embedded-PC CX20x0. The Embedded-PC CX20x0 is part of a modular system and belongs to the CX2000 Embedded PC series. Further information on the devices of the CX2000 Embedded PC series can be found in the associated documentation. Read and follow in particular the sections on safety in this documentation.

The following important documentation can be viewed at and downloaded from the Beckhoff website:  
<http://www.beckhoff.de>

Document name
CX2100-00x4 power supply unit for CX20x0
CX2100-09x4 UPS power supply unit for CX20x0

### Retaining the documentation

This documentation is part of the Embedded-PC. Keep the documentation in the immediate vicinity of the battery pack throughout its entire service life. Ensure that personnel have access to the documentation at all times. Pass on the documentation to subsequent users, and in addition ensure that all supplementary information is included in the documentation.

## 1.3 Documentation issue status

Version	Changes
1.0	First Version
1.1	Notes on power connections added, order numbers for CX20x0-N031 added
1.2	New types added
1.3	UL requirements added
1.4	Chapter "DVI-D port" and "module overview" added.
1.5	Chapter "Types" reworked.
1.6	Chapter "NOVRAM" and "USV (persistent data)" added.
1.7	Documentation restructured and revised.
1.8	Chapter „Using a hardware watchdog“ added.

## 2 For your safety

Read the chapter on safety and follow the instructions in order to protect from personal injury and damage to equipment.

### Limitation of liability

All the components are supplied in particular hardware and software configurations appropriate for the application. Unauthorized modifications and changes to the hardware or software configuration, which go beyond the documented options, are prohibited and nullify the liability of Beckhoff Automation GmbH & Co. KG.

In addition, the following actions are excluded from the liability of Beckhoff Automation GmbH & Co. KG:

- Failure to comply with this documentation.
- Improper use.
- Use of untrained personnel.
- Use of unauthorized replacement parts.

## 2.1 Intended use

The CX2000 Embedded PC series is a modular control system, which is intended for installation on a DIN rail. The system is scalable, so that the basic PC modules, power supply units, system modules and extension modules can be assembled and installed in the control cabinet or terminal box as required.

The CX2000 Embedded PC series is used in conjunction with Bus Terminals for recording digital and analog signals from sensors and transferring them to actuators or higher-level controllers. The CX2000 Embedded PC series combines the worlds of Industrial PC and hardware PLC and is suitable for control tasks.

The Embedded PC is designed for a working environment that meets the requirements of protection class IP20. This involves finger protection and protection against solid foreign objects up to 12.5 mm, but not protection against water. Operation of the devices in wet and dusty environments is not permitted, unless specified otherwise. The specified limits for electrical and technical data must be adhered to.

### Improper use

The Embedded PC is not suitable for operation in the following areas:

- Potentially explosive atmospheres.
- Areas with an aggressive environment, e.g. aggressive gases or chemicals.
- Living areas. If the devices are to be used in living areas, the relevant standards and guidelines for interference emissions must be adhered to, and the devices must be installed in housings or control boxes with suitable shielding.

## 2.2 Staff qualification

All operations involving Beckhoff software and hardware may only be carried out by qualified personnel with knowledge of control and automation engineering. The qualified personnel must have knowledge of the administration of the Embedded PC and the associated network.

All interventions must be carried out with knowledge of control programming, and the qualified personnel must be familiar with the current standards and guidelines for the automation environment.

## 2.3 Safety instructions

The following safety instructions must be followed during installation and working with networks and the software.

### Mounting

- Never work on live equipment. Always switch off the power supply for the device before installation, troubleshooting or maintenance. Protect the device against unintentional switching on.
- Observe the relevant accident prevention regulations for your machine (e.g. the BGV A 3, electrical systems and equipment).
- Ensure standard-compliant connection and avoid risks to personnel. Ensure that data and supply cables are laid in a standard-compliant manner and ensure correct pin assignment.
- Observe the relevant EMC guidelines for your application.
- Avoid polarity reversal of the data and supply cables, as this may cause damage to the equipment.
- The devices contain electronic components, which may be destroyed by electrostatic discharge when touched. Observe the safety precautions against electrostatic discharge according to DIN EN 61340-5-1/-3.

### Working with networks

- Restrict access to all devices to an authorized circle of persons.
- Change the default passwords to reduce the risk of unauthorized access. Regularly change the passwords.
- Install the devices behind a firewall.
- Apply the IT security precautions according to IEC 62443, in order to limit access to and control of devices and networks.

### Working with the software

- Use up-to-date security software. The safe function of the PC can be compromised by malicious software such as viruses or Trojans.
- The sensitivity of a PC against malicious software increases with the number of installed and active software.
- Uninstall or disable unnecessary software.

Further information about the safe handling of networks and software can be found in the Beckhoff Information System:

<http://infosys.beckhoff.de>

Document name
Documentation about IPC Security



### 3 Transport and storage

#### Transport

 <b>Attention</b>	<p><b>Short circuit due to moisture</b></p> <p>Moisture can form during transport in cold weather or in the event of large temperature fluctuations.</p> <p>Avoid moisture formation (condensation) in the Embedded PC, and leave it to adjust to room temperature slowly. If condensation has occurred, wait at least 12 hours before switching on the Embedded PC.</p>
---	--

Despite the robust design of the unit, the components are sensitive to strong vibrations and impacts. During transport the Embedded PC must be protected from

- mechanical stress and
- use the original packaging.

*Table 1: Dimensions and weight of the individual modules.*

	<b>CX2020</b>	<b>CX2030</b>	<b>CX2040</b>
Dimensions (W x H x D)	144 mm x 99 mm x 91 mm		
Weight	approx. 1160 g	approx. 1165 g	approx. 1230 g

#### Storage

- The battery should be removed if the Embedded PC is stored at temperatures above 60 °C. The battery should be stored separate from the Embedded PC in a dry environment at a temperature between 0 °C and 30 °C.  
The preset date and time are lost if the battery is removed.
- Store the Embedded PC in the original packaging.

## 4 Product overview

The CX2000 product family consists of individual modules, which can be assembled to form a customized Embedded PC.

The CX2000 product family consists of:

- basic CPU modules,
- CX2100 power supply units,
- system, fieldbus and extension modules,
- and the CX2900 battery pack.

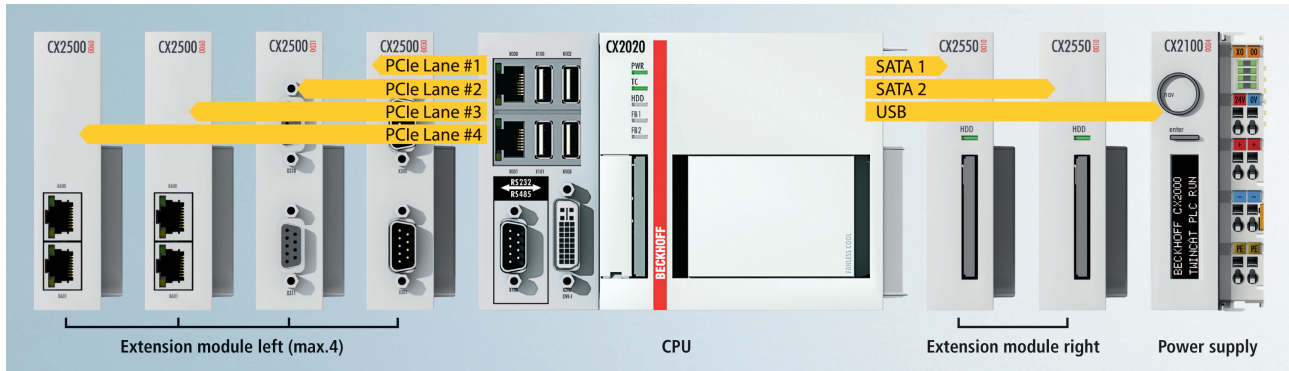

Fig. 1: Overview of the CX2000 product family with basic CPU module, power supply unit and modules.

### Basic CPU module

The basic CPU module is a fully functional PC and can be used in conjunction with a CX2100 power supply unit as the smallest possible configuration. The basic configuration of the CX2000 Embedded PC includes:

- a CFast card slot,
- two independent Gbit Ethernet interfaces,
- four USB 2.0 interfaces,
- and a DVI-I interface.

The basic CPU module can be extended with additional interfaces or storage media, as required. Up to four system or fieldbus modules can be connected on the left-hand side of the basic CPU module. Up to four extension modules can be connected on the right-hand side between the basic CPU module and the power supply unit. Two extension modules for additional storage media (CFast card, SSD) and two extension modules for a USB extension.

Suitable operating systems are Microsoft Windows 10 IoT Enterprise LTSC, Microsoft Windows Embedded Standard 7 P or Microsoft Windows Embedded Compact 7.

The basic CPU module features 128 kB NOVRAM as internal persistent data memory and can be used as an alternative to a power supply unit with capacitive UPS or an external battery pack. In the event of a power failure, important data are stored in the NOVRAM and are available again after a restart.

The basic CPU module can be ordered ex factory with an optional interface. The optional interface cannot be retrofitted.

Table 2: Available optional interfaces for the CX20x0.

CX20x0-xxxx	Optional interfaces
CX20x0-N010	DVI-D, additional DVI-D socket for clone and extended display mode.
CX20x0-N011	DisplayPort, additional DisplayPort for clone and extended display mode
CX20x0-N030	RS232, D-sub connector, 9-pin.
CX20x0-N031	RS422/RS485, D-sub socket, 9-pin.
CX20x0-B110	EtherCAT slave, EtherCAT IN and OUT (2 x RJ45).
CX20x0-M310	PROFIBUS master, D-sub socket, 9-pin.
CX20x0-B310	PROFIBUS slave, D-sub socket, 9-pin.
CX20x0-M510	CANopen master, D-sub connector, 9-pin.
CX20x0-B510	CANopen slave, D-sub connector, 9-pin.
CX20x0-M930	PROFINET RT, controller, Ethernet (2 x RJ-45).
CX20x0-B930	PROFINET RT, device, Ethernet (2 x RJ-45 switch).

### CX2100 power supply units

The CX2100 power supply units serve the basic CPU module and all additional modules. Bus Terminals (K-bus) or EtherCAT Terminals (E-bus) can be attached on the right-hand side of the power supply units. The power supply units are available in four different versions:

- CX2100-0004: E-bus/K-bus power supply unit with automatic switchover.
- CX2100-0014: E-bus/K-bus power supply unit with automatic switchover and passive ventilation.
- CX2100-0904: E-bus/K-bus power supply unit with automatic switchover and integrated capacitive UPS.
- CX2100-0914: E-bus/K-bus power supply unit with automatic switchover and integrated electronic charging unit for an external battery pack.

All power supply units feature an illuminated anti-glare LC display with two rows of 16 characters each for displaying status messages. Application-specific texts can be displayed with the aid of user programs.

### System, fieldbus and extension modules

System or fieldbus modules of type CX2500-xxxx can be connected on the left-hand side of the basic CPU module. Up to four modules can be connected to the multi-pin connection on the left. Extension modules of type CX2550 can be connected on the right between the basic CPU module and the power supply unit.

### CX2900 battery pack

The battery pack is a charge store for the CX2000 product family and used as UPS in conjunction with the CX2100-0914 power supply unit. In the event of a power failure the battery pack supplies the basic CPU module and further devices (e.g. a Panel) via the CX2100-0914 power supply unit.

### Software

In combination with the TwinCAT automation software, the CX20x0 Embedded PC becomes a powerful IEC 61131-3 PLC with up to four user tasks. In conjunction with EtherCAT and TwinCAT, it is possible to implement very fast control processes in the microsecond range (XFC eXtreme Fast Control Technology). It is also possible to execute Motion Control tasks with potentially up to 256 axes. Depending on the required sampling time, several servo axes can be controlled. Even special functions such as flying saw, electronic gearbox and cam plate can be realized.

In addition to handling real-time control tasks the TwinCAT real-time kernel leaves enough time for the user interface (HMI). The high performance of the graphics core integrated in the CPU enables demanding visualizations with advanced user interfaces to be realized.

## 4.1 Configuration of the basic CPU module

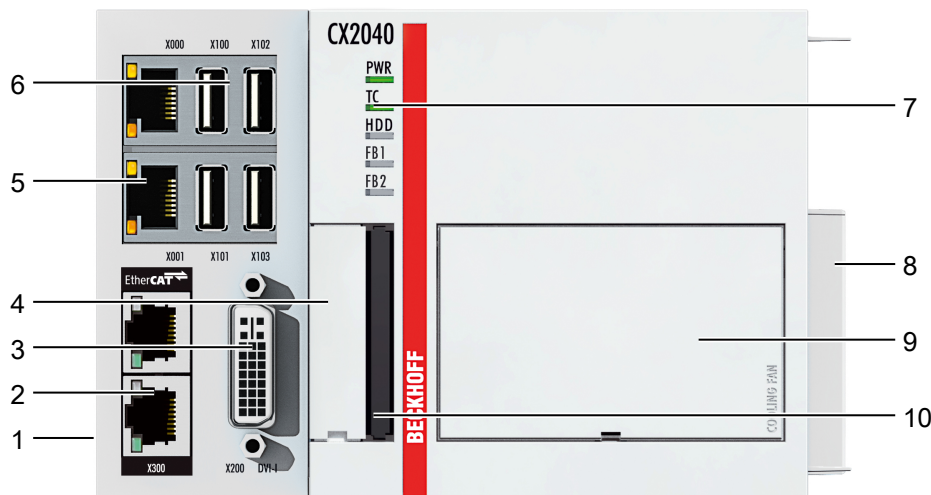

Fig. 2: Example: Embedded PCs CX2040 with active cooling.

Table 3: Legend for the configuration of the basic CPU module

No.	Component	Description
1	Multi-pin connection (left)	Extension through system modules and fieldbus modules of type CX2500.
2	Optional interface [▶ 22] (X300).	Space for interfaces such as RS232, EtherCAT, CANopen or others. The optional interface must be ordered ex factory and cannot be retrofitted retrospectively.
3	DVI-I interface [▶ 21] (X200).	Interface for a monitor or Panel.
4	Battery compartment [▶ 74] (under the front flap).	Power supply for the battery-backed clock for time and date.
5	RJ45 Ethernet interfaces [▶ 20] (X000, X001).	For connecting to local networks, internet or EtherCAT.
6	USB interfaces [▶ 19] (X100, X101, X102, X103).	Interfaces for peripherals such as mouse, keyboard or USB memory.
7	Diagnostic LEDs. [▶ 69]	Diagnostic LEDs for power supply, TwinCAT, CFast card and optional interface.
8	Multi-pin connection (right)	Connection for extension modules of type CX2550 and for power supply units of type CX2100.
9	Fan cartridge [▶ 75] (under the front flap).	The fan cartridge is provided as standard for the CX2040. The CX2020 and CX2030 can be ordered with active cooling ex factory.
10	CFast card slot. [▶ 35]	Slot for industrial CFast cards.

## 4.2 Name plate

The CX20x0 Embedded PC features a name plate on the left-hand side of the housing.

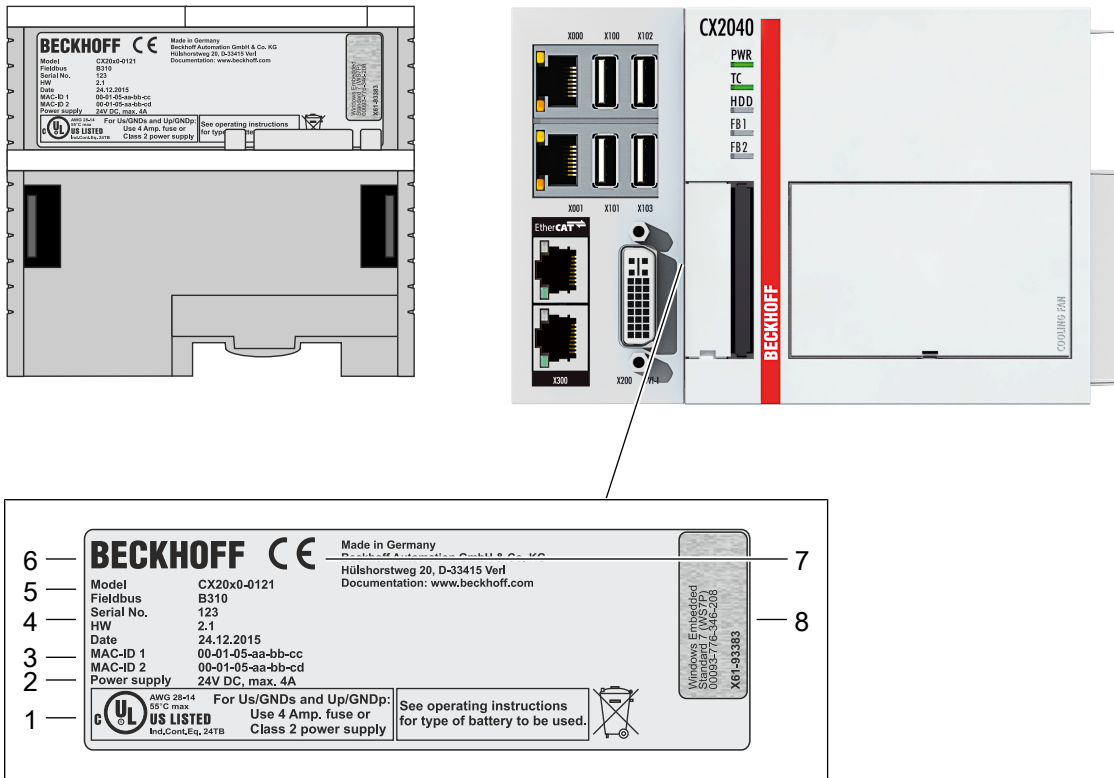
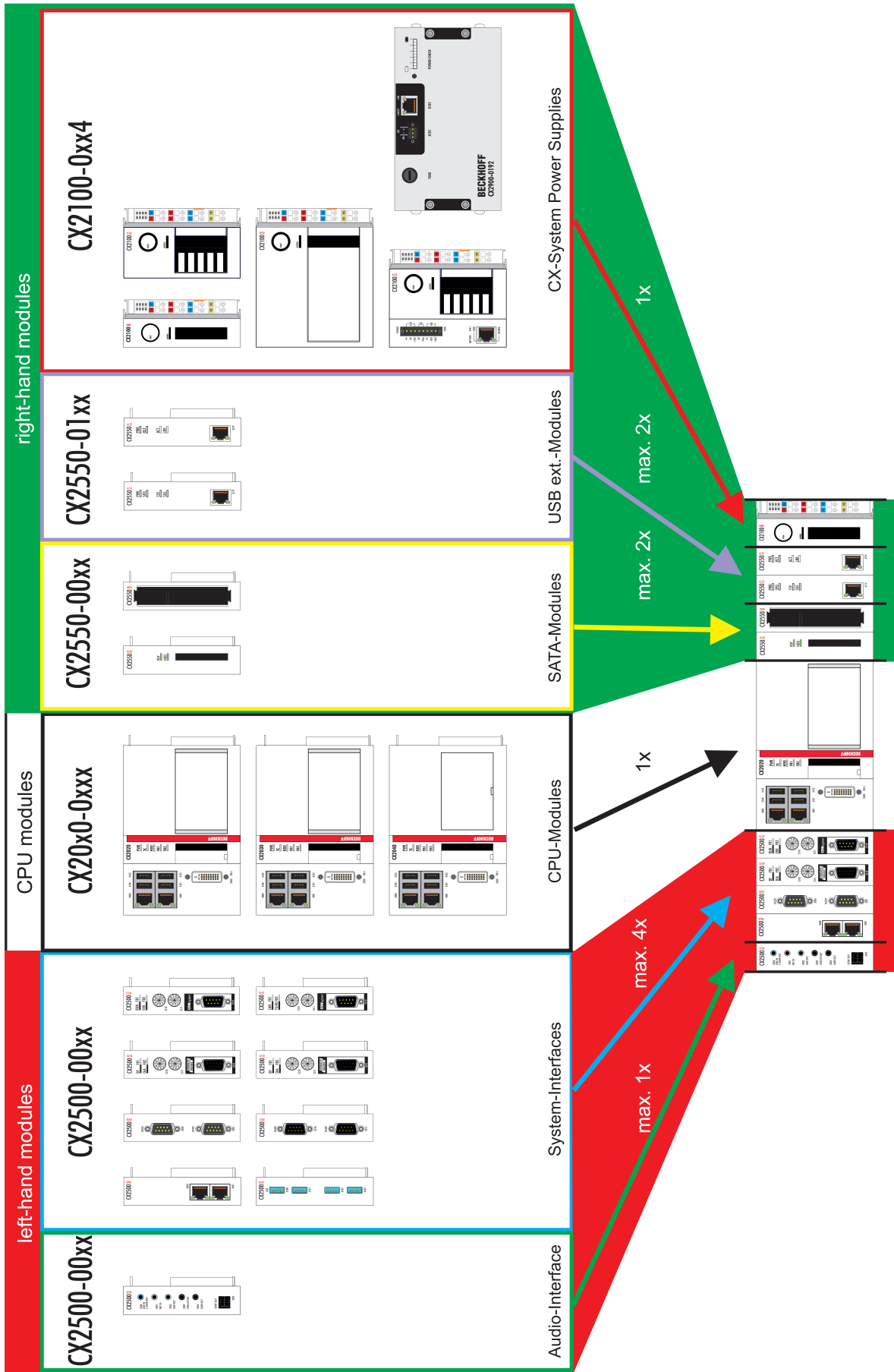

Fig. 3: CX20x0 name plate.

Table 4: Legend for the name plate.

No.	Description
1	UL approval with prescribed information on power supply, fuse, temperature and cable cross-sections.
2	Information on the power supply unit. 24 V DC, 4 A max.
3	MAC addresses of the integrated Ethernet ports. By default, the host name is formed from "CX-" plus the last 3 bytes of the MAC address: Example: the host name <b>CX-aabbcc</b> is formed from the MAC address 00-01-05-aa-bb-cc.
4	Information on: <ul style="list-style-type: none"> <li>• serial number,</li> <li>• hardware version</li> <li>• and date of manufacture.</li> </ul>
5	Information on the model. The last four numerals relate to the configuration of Embedded PC.
6	Manufacturer information including address.
7	CE compliant.
8	Windows license sticker (optional).

### 4.3 Module overview



## 4.4 Types

The basic CPU module can be ordered with different hardware and software options. Use this overview in conjunction with the information on the name plate to ascertain the hardware, operating system and TwinCAT version of the basic CPU module.

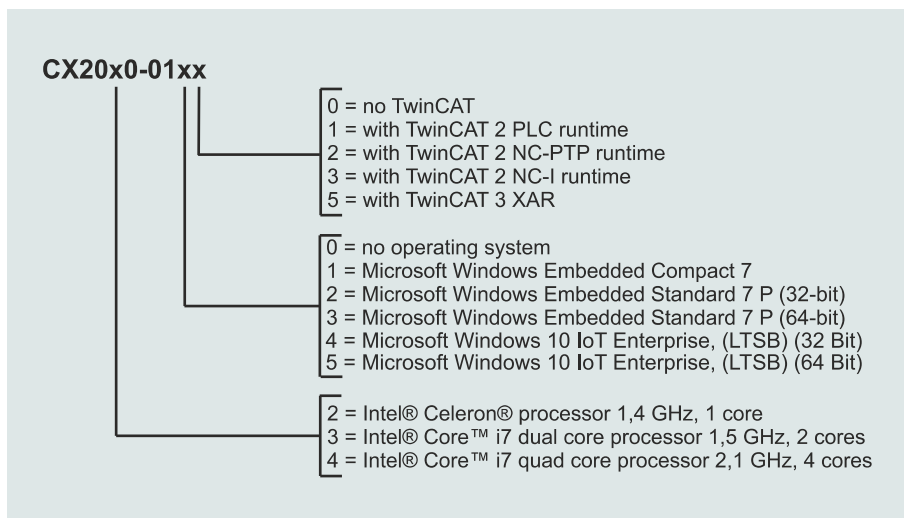

Fig. 4: Nomenclature for the basic CPU module.

The basic CPU module CX2020, CX2030 and CX2040 is available with the following software options:

Table 5: CX20x0, ordering information for software.

Module	no operating system	Windows Embedded Compact 7	Windows Embedded Standard 7 P (32-Bit)	Windows Embedded Standard 7 P (64-Bit)	Windows 10 IoT Enterprise, 32 Bit	Windows 10 IoT Enterprise, 64 Bit	no Twin-CAT	Twin-CAT 2 PLC- Runtime	Twin-CAT 2 NC-PTP- Runtime	Twin-CAT 2 NC-I- Runtime	Twin-CAT 3 XAR
CX20x0-0100	X	-	-	-	-	-	X	-	-	-	-
CX20x0-0110	-	X	-	-	-	-	X	-	-	-	-
CX20x0-0111	-	X	-	-	-	-	-	X	-	-	-
CX20x0-0112	-	X	-	-	-	-	-	-	X	-	-
CX20x0-0113	-	X	-	-	-	-	-	-	-	X	-
CX20x0-0115	-	X	-	-	-	-	-	-	-	-	X
CX20x0-0120	-	-	X	-	-	-	X	-	-	-	-
CX20x0-0121	-	-	X	-	-	-	-	X	-	-	-
CX20x0-0122	-	-	X	-	-	-	-	-	X	-	-
CX20x0-0123	-	-	X	-	-	-	-	-	-	X	-
CX20x0-0125	-	-	X	-	-	-	-	-	-	-	X
CX20x0-0130	-	-	-	X	-	-	X	-	-	-	-
CX20x0-0135	-	-	-	X	-	-	-	-	-	-	X
CX20x0-0140	-	-	-	-	X	-	X	-	-	-	-
CX20x0-0141	-	-	-	-	X	-	-	X	-	-	-
CX20x0-0142	-	-	-	-	X	-	-	-	X	-	-
CX20x0-0143	-	-	-	-	X	-	-	-	-	X	-
CX20x0-0150	-	-	-	-	-	X	X	-	-	-	-
CX20x0-0155	-	-	-	-	-	X	-	-	-	-	X

A CX20x0 Embedded PC with Microsoft Windows Embedded Standard 7 P (32-bit) requires a CFast card with a minimum capacity of 8 GB. For Microsoft Windows Embedded Standard 7 P (64-bit) and Microsoft Windows 10 IoT Enterprise (32- and 64-bit) a CFast card with a minimum capacity of 16 GB is required.



## 4.5 Architecture overview

The Embedded PCs of the CX20x0 family all have the same architecture. The architecture is described below.

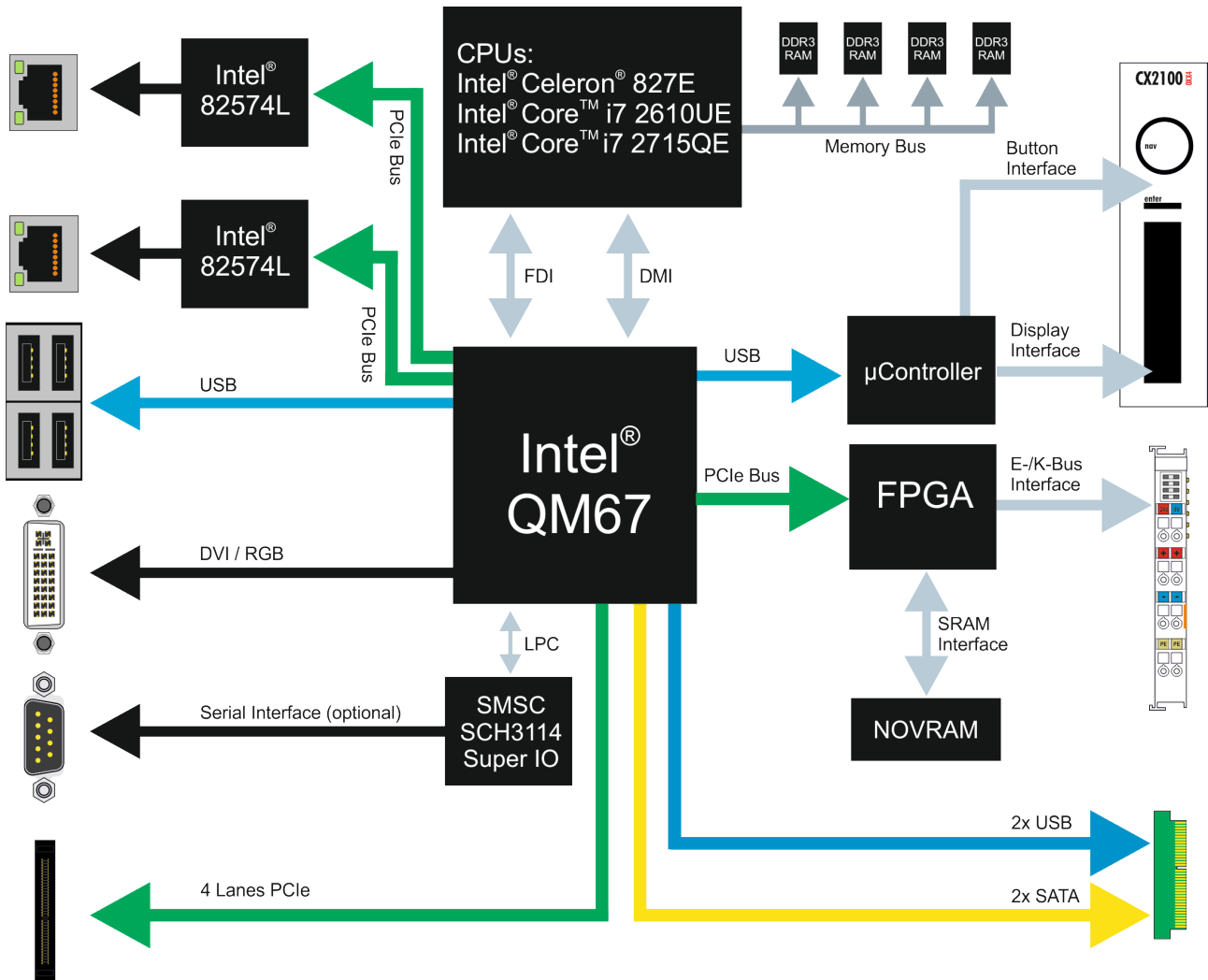

Fig. 5: CX20x0 architecture overview.

The CX20x0 Embedded PCs are based on the Sandy Bridge microarchitecture developed by Intel. The following CPUs are used:

- Intel®Celeron® 827E (Singlecore),
- Intel®CORE™ i7 2610UE (Dualcore),
- and Intel®Core™ i7 2715QE (Quadcore).

In addition to the arithmetic unit, the CPU also contains the memory controller and the graphics controller. The single-core processor uses the Intel® HD has as graphics core. The two Core™ i7 CPUs (dual or quad core) feature an Intel® HD graphics 3000 core. This offers a somewhat higher performance than the Intel® HD graphics core, and the quad core offers a higher clock speed. For details on the CPUs please refer to Intel. The memory is connected directly to the memory controller. The Embedded PCs are available in two memory configurations: 2GB or 4GB DDR3 RAM. The memory is not expandable and must be ordered ex factory.

All CX20x0 Embedded PCs use the Mobile Intel® QM67 Express chipset (Intel® BD82QM67 PCH). This chip provides all required interfaces:

- 4 x USB 2.0
- 1x USB 2.0 internal (power supply unit control button / display).
- DVI-I and DVI-D interface (second interface optional CX20x0-N010).

- 1 PCIe lane for each of the two Intel® 82574L Gigabit Ethernet controllers
- LPC interface for super I/O controller for serial interface (CX20x0-N03x).
- 4 PCIe lanes via the multi-pin connection (left).
- 1 PCIe to FPGA for K-/E-bus and NOVRAM.
- 2x SATA internal via the multi-pole connection (right).
- 2x USB internal via the multi-pin connection (right).

The interfaces (USB, DVI, and LAN) are standard interfaces. Devices that meet the corresponding standard can be connected to and operated at these interfaces. A VGA monitor can be connected to the DVI-I interface with an adapter.

Intel® 82574L Gigabit Ethernet controllers are used as network controllers. There are two independent LAN interfaces. Both LAN interfaces are gigabit-capable and support jumbo frames.

## 5 Description of the interfaces

### 5.1 USB (X100, X101, X102, X103)

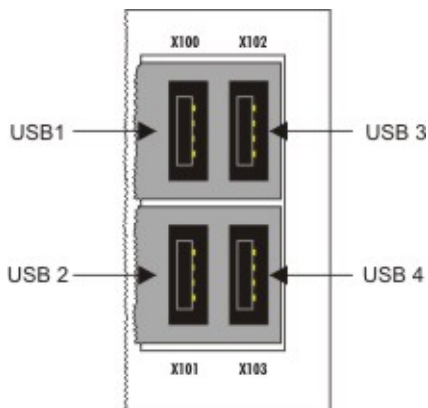

Fig. 6: USB interfaces (X100, X101, X102, X103).

The Embedded PC has four independent USB interfaces for connecting keyboards, mice, touchscreens and other input or data storage devices.

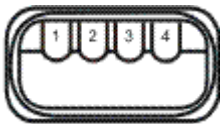

Fig. 7: USB interface, pin numbering.

Note the power consumption of the individual devices. Each interface is limited to 500 mA. The USB interface is of type A and corresponds to the USB 2.0 specification.

Table 6: USB interfaces (X100, X101, X102, X103), pin assignment.

Pin	Assignment	Typical assignment
1	VBUS	Red
2	D-	White
3	D+	Green
4	GND	Black
Shell	Shield	Drain Wire

## 5.2 Ethernet RJ45 (X000, X001)

The two Ethernet interfaces are independent; no switch is integrated. The independent Ethernet interfaces can be configured in different ways. In delivery state the Ethernet interfaces (X000, X001) are configured for EtherCAT communication.

Note that an additional switch is required for a line topology.

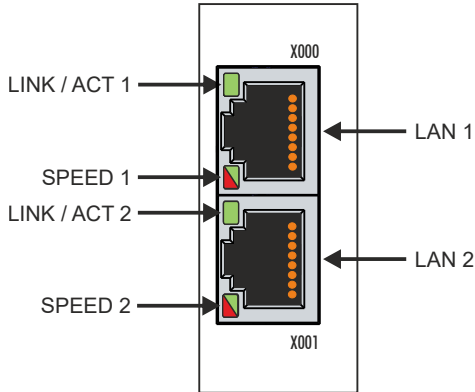

Fig. 8: Ethernet interface X000, X001.

Both Ethernet interfaces reach speeds of 10 / 100 / 1000 Mbit. The LEDs on the left of the interfaces indicate the connection status. The upper LED (LINK/ACT) indicates whether the interface is connected to a network. If this is the case the LED is green. The LED flashes when data transfer is in progress.

The lower LED (SPEED) indicates the connection speed. The LED does not light up if the speed is 10 Mbit. The LED is green if the speed is 100 Mbit. The LED lights up red if the speed is 1000 Mbit (gigabit).



Fig. 9: Ethernet interface, pin numbering.

Table 7: Ethernet interface X000 and X001, pin assignment.

PIN	Signal	Description
1	T2 +	Pair 2
2	T2 -	
3	T3 +	Pair 3
4	T1 +	Pair 1
5	T1 -	
6	T3 -	Pair 3
7	T4 +	Pair 4
8	T4 -	

### 5.3 DVI-I (X200)

The DVI-I interface (X200) transfers digital data and is suitable for connection to digital or analog monitors. The resolution at the display or the Beckhoff Control Panel depends on the distance from the display device. The maximum distance is 5 m. Beckhoff offers various Panels with an integrated “DVI extension”. These make a cable length of up to 50 meters possible.

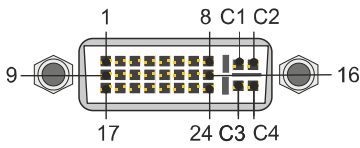

Fig. 10: DVI-I interface X200.

Table 8: DVI-I interface X200, pin assignment.

Pin	Assignment	Pin	Assignment	Pin	Assignment
1	TMDS Data 2-	9	TMDS Data 1-	17	TMDS Data 0-
2	TMDS Data 2+	10	TMDS Data 1+	18	TMDS Data 0+
3	TMDS Data 2/4 Shield	11	TMDS Data 1/3 Shield	19	TMDS Data 0/5 Shield
4	not connected	12	not connected	20	not connected
5	not connected	13	not connected	21	not connected
6	DDC Clock	14	+ 5V Power	22	TMDS Clock Shield
7	DDC Data	15	Ground ( +5V, Analog H/V Sync)	23	TMDS Clock +
8	Analog Vertical Sync	16	Hot Plug Detect	24	TMDS Clock -

Table 9: DVI-I cross, pin assignment.

Pin	Assignment
C1	Analog Red Video Out
C2	Analog Green Video Out
C3	Analog Blue Video Out
C4	Analog Horizontal Sync

Table 10: DVI-I interface X200, resolution at the monitor.

Resolution in pixels	Distance of the interface from the monitor
1920 x 1200	5 m
1920 x 1080	5 m
1600 x 1200	5 m
1280 x 1024	5 m
1024 x 768	5 m
800 x 600	5 m
640 x 480	5 m

The Embedded PC also supports higher resolutions, based on the DVI standard. A maximum resolution of 2560 x 1440 pixels can be set on the Embedded PC. Whether this resolution is achieved depends on the monitor, the cable quality and the cable length.

## 5.4 Optional interfaces

### 5.4.1 DVI-D (N010)

The DVI-D interface (X300) transfers digital data and is suitable for connection to digital displays. If the optional N010 interface (DVI-D interface) is used, the first DVI-I interface can be operated either in VGA mode or in DVI mode. The resolution at the display or the Beckhoff Control Panel depends on the distance from the display device. The maximum distance is 5 m. Beckhoff offers various Panels with an integrated "DVI extension". These make a cable length of up to 50 meters possible.

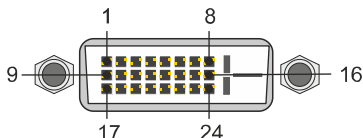

Fig. 11: DVI-D interface X300.

Table 11: DVI-D interface X300, pin assignment.

Pin	Assignment	Pin	Assignment	Pin	Assignment
1	TMDS Data 2-	9	TMDS Data 1-	17	TMDS Data 0-
2	TMDS Data 2+	10	TMDS Data 1+	18	TMDS Data 0+
3	TMDS Data 2/4 Shield	11	TMDS Data 1/3 Shield	19	TMDS Data 0/5 Shield
4	not connected	12	not connected	20	not connected
5	not connected	13	not connected	21	not connected
6	DDC Clock	14	+ 5V Power	22	TMDS Clock Shield
7	DDC Data	15	Ground ( +5V, Analog H/V Sync)	23	TMDS Clock +
8	Analog Vertical Sync	16	Hot Plug Detect	24	TMDS Clock -

Table 12: DVI-D interface X300, resolution at the monitor.

Resolution in pixels	Distance of the interface from the monitor
1920 x 1200	5 m
1920 x 1080	5 m
1600 x 1200	5 m
1280 x 1024	5 m
1024 x 768	5 m
800 x 600	5 m
640 x 480	5 m

The Embedded PC also supports higher resolutions, based on the DVI standard. A maximum resolution of 2560 x 1440 pixels can be set on the Embedded PC. Whether this resolution is achieved depends on the monitor, the cable quality and the cable length.

## 5.4.2 DisplayPort (N011)

The DisplayPort transfers image and audio signal at the same time and is therefore suitable for connecting panels or monitors to the Embedded PC.

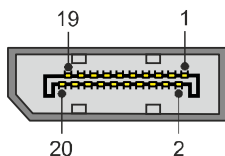

Fig. 12: DisplayPort X300.

Version 1.1a of the DisplayPort (DisplayPort++) is installed on the Embedded PC. Adapters from DisplayPort to DVI-D or DisplayPort to HDMI can be used to connect monitors without DisplayPort to the Embedded PC.

Table 13: DisplayPort, pin assignment.

Pin	Assignment	Pin	Assignment
1	LVDS lane 0+	2	Ground
3	LVDS lane 0-	4	LVDS lane 1+
5	Ground	6	LVDS lane 1-
7	LVDS lane 2+	8	Ground
9	LVDS lane 2-	10	LVDS lane 3+
11	Ground	12	LVDS lane 3-
13	Config 1	14	Config 2
15	AUX channel+	16	Ground
17	AUX channel-	18	Hot-plug detection
19	Power supply: ground	20	Power supply: 3.3 V / 500 mA

Table 14: DisplayPort X300, resolution at the monitor.

Interface	Resolution in pixels
DisplayPort	max. 2560 x 1600 @ 60 Hz
DisplayPort with adapter, DisplayPort to DVI-D	max. 1600 x 1200 @ 60 Hz



### 5.4.3 RS232 (N030)

The optional N030 interface provides an RS232 interface (X300). The RS232 interface is implemented on a 9-pin D-sub connector.

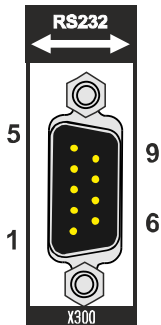

Fig. 13: RS232 interface X300 with pin numbering.

The maximum baud rate on both channels is 115 kbit. The interface parameters are set via the operating system or from the PLC program.

Table 15: RS232 interface X300, pin assignment.

PIN	Signal	Type	Description
1	DCD	Signal in	Data Carrier Detected
2	RxD	Signal in	Receive Data
3	TxD	Signal out	Transmit Data
4	DTR	Signal out	Data Terminal Ready
5	GND	Ground	Ground
6	DSR	Signal in	Dataset Ready
7	RTS	Signal out	Request to Send
8	CTS	Signal in	Clear to Send
9	RI	Signal in	Ring Indicator

### 5.4.4 RS422/RS485 (N031)

The optional N031 interface provides an RS422 or RS485 interface (X300). The interface is implemented on a 9-pin D-sub connector.

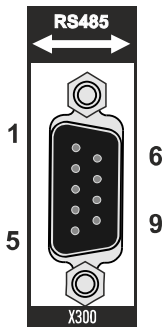

Fig. 14: RS485 interface X300 with pin numbering.

The maximum baud rate on both channels is 115 kbit. The interface parameters are set via the operating system or from the PLC program.

Table 16: RS422/485 interface, pin assignment.

PIN	Signal	Type	Description
2	TxD+	Data-Out +	Transmit 422
3	RxD+	Data-In +	Receive 422
5	GND	Ground	Ground
6	VCC	VCC	+5 V
7	TxD-	Data-Out -	Transmit 422
8	RxD-	Data-In -	Receive 422

For RS485 pins 2 and 3 (data +) must be connected, and pins 7 and 8 (data –).

By default the interface is parameterized as follows on delivery:

Table 17: Default setting, RS485 without echo with end point (terminated).

Function	Status
Echo on	off
Echo off	on
Auto send on	on
Always send on	off
Auto receive on	on
Always receive on	off
Term on	on
Term on	On

#### Other configurations for the RS485 interface

Other configurations for the RS485 interface can be ordered ex factory. The following options are available:

- N031-0001 RS485 with echo, end point (terminated).
- N031-0002 RS485 without echo, stub (without termination).
- N031-0003 RS485 with echo, stub (without termination).
- N031-0004 RS422 full duplex end point (terminated).

An RS485 interface cannot be configured retrospectively and must always be ordered ex factory as required.

### 5.4.5 EtherCAT slave (B110)

The latest generation of Embedded PCs can be ordered ex factory with an EtherCAT slave interface (B110). On the devices the optional B110 interface is referred to as X300.

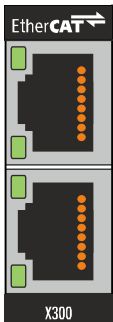

Fig. 15: EtherCAT slave interface X300.

The incoming EtherCAT signal is connected to the upper LAN interface. The lower LAN interface relays the signal to other EtherCAT slave devices.



Fig. 16: EtherCAT slave LAN interface, pin numbering.

Table 18: EtherCAT slave interface X300, pin assignment.

PIN	Signal	Description
1	TD +	Transmit +
2	TD -	Transmit -
3	RD +	Receive +
4	connected	reserved
5		
6	RD -	Receive -
7	connected	reserved
8		

For the optional EtherCAT slave interface (B110), documentation with further information is available for download from the Beckhoff website:

<https://www.beckhoff.de/german/download/epc.htm?id=71003127100362>

Document name
CXxxx0-B110 optional interface EtherCAT slave.

### 5.4.6 PROFIBUS (x310)

Pin 6 transfers 5 V<sub>DC</sub>, pin 5 transfers GND for the active termination resistor. These must never be used for other functions, as this can lead to destruction of the device.

Pins 3 and 8 transfer the PROFIBUS signals. These must never be swapped over, as this will prevent communication.

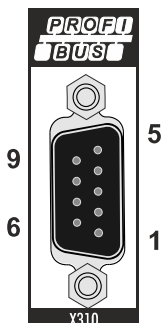

Fig. 17: PROFIBUS interface X310 with pin numbering.

The Profibus bus line is connected via a 9-pin D sub with the following pin assignment:

Table 19: PROFIBUS interface X310, pin assignment.

Pin	Assignment
1	Shielding
2	not used
3	RxD/TxD-P
4	not used
5	GND
6	+5 V <sub>DC</sub>
7	not used
8	RxD/TxD-N
9	not used

Table 20: Wire colors of the PROFIBUS line.

PROFIBUS line	D sub
B red	Pin 3
A green	Pin 8

For the optional PROFIBUS interface (x310), documentation with further information is available for download from the Beckhoff website:

<https://www.beckhoff.de/german/download/epc.htm?id=71003127100362>

Document name
CXxxx0-x310 optional Profibus interface.

### 5.4.7 CANopen (x510)

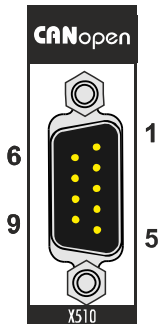

Fig. 18: CANopen interface X510 with pin numbering.

The CAN bus line is connected via a 9-pin D-sub socket with the following configuration:

Table 21: CANopen interface X510, pin assignment.

Pin	Assignment
1	not used
2	CAN low (CAN-)
3	CAN ground (internally connected to pin 6)
4	not used
5	Shield
6	CAN ground (internally connected to pin 3)
7	CAN high (CAN+)
8	not used
9	not used

For the optional CANopen interface (x510), documentation with further information is available for download from the Beckhoff website:

<https://www.beckhoff.de/german/download/epc.htm?id=71003127100362>

Document name
CXxxx0-x510 optional CANopen interface.

### 5.4.8 PROFINET RT (x930)

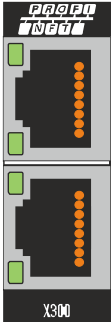

Fig. 19: PROFINET RT interface X300.



Fig. 20: PROFINET RT LAN interface, pin numbering.

Table 22: PROFINET RT interface, pin assignment.

PIN	Signal	Description
1	TD +	Transmit +
2	TD -	Transmit -
3	RD +	Receive +
4	connected	reserved
5		
6	RD -	Receive -
7	connected	reserved
8		

## 6 Commissioning

### 6.1 Selecting the appropriate CX2100 power supply unit

The basic CPU module requires a power supply unit of type CX2100-0xxx. Connect the power supply unit to the multi-pin port on the right of the basic CPU module.

Any power supply unit of type CX2100-0xxx can be used for the CX2020 and CX2030 Embedded PCs with passive cooling.

Table 23: Power supply units for basic CPU modules with passive cooling.

Basic CPU module	Power supply units
CX2020	CX2100-0004 (45 W)
CX2030	CX2100-0014 (90 W)
	CX2100-0904 (45 W, capacitive UPS)
	CX2100-0914 (90 W, external battery pack can be used)

The Embedded PCs CX2020 and CX2030 can be ordered with active cooling ex factory, for operation in vertical or horizontal installation position. In this case only CX2100-0014 or CX2100-0914 power supply units should be used, which feature additional ventilation openings and larger heat sinks.

The Embedded PC CX2040 is equipped with a fan cartridge as standard. It can be operated in vertical or horizontal installation position and requires power supply units of type CX2100-0014 or CX2100-0914.

Table 24: Power supply units for basic CPU modules with active cooling.

Basic CPU module	Accessories	Power supply units
CX2020	Fan option CX2900-0200	CX2100-0014 (90 W)
CX2030	Fan option CX2900-0300	-or-
CX2040	-	CX2100-0914 (90 W, external battery pack can be used)

#### Configuration of the power supply terminal



Fig. 21: Embedded PC CX2020 with power supply unit CX2100-0004, configuration of the power supply terminal.

Table 25: Legend for configuration of the power supply terminal.

No.	Description	No.	Description
1	Diagnostic LEDs	5	0 V, Bus Terminal supply
2	Terminal bus (K- or E-bus)	6	Terminal release
3	+24 V and 0 V, for basic CPU module	7	PE, spring-loaded terminal
4	+24 V, Bus Terminal supply	8	+24 V, 0 V, PE, for power contacts



## 6.2 Mounting

### 6.2.1 Attaching the power supply unit

The basic CPU module requires a power supply unit of type CX2100-0xxx. Connect the power supply unit to the multi-pin port on the right of the basic CPU module.

Proceed as follows:

1. Select the appropriate power supply unit, as described in chapter [Selecting the appropriate CX2100 power supply unit](#) [▶ 30].
2. Attach the power supply unit on the right of the basic CPU module.

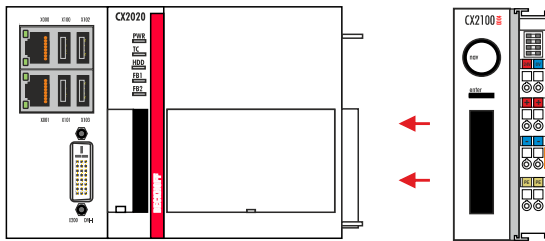

⇒ Next you can install the bar clips.

### 6.2.2 Installing the bar clips

Usually, the connection between the modules is strong enough. However, the basic CPU module and the attached modules may be subjected to shocks, vibrations or other impacts. The modules can be securely connected to one another with the aid of bar clips.

Install the bar clips as follows:

1. Attach the bar clips at the top and bottom between the cooling fins.

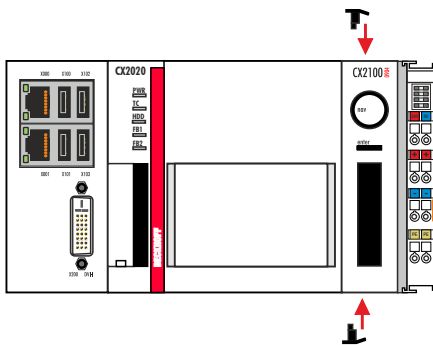

2. Push the bar clips between the cooling fins of your devices, as shown in the image below.



⇒ The bar clips have been installed successfully, if they don't protrude and are level with the cooling fins of your modules.  
Once all modules are latched, the devices can be installed on the mounting rail.

### 6.2.3 Note the permissible installation positions

 <b>Note</b>	<p><b>Increased heat generation</b></p> <p>The Embedded PC may overheat if the installation position is incorrect or the minimum distances are not adhered to.</p> <p>The Embedded PC may only be operated at ambient temperatures of up to 60 °C. Ensure adequate ventilation. Select a horizontal installation position. Leave at least 30 mm clearance above and below the Embedded PC.</p>
--	--

Install the Embedded PC horizontally in the control cabinet on a mounting rail, in order to ensure optimum heat dissipation. Only Embedded PCs with active cooling can be operated vertically or horizontally.

Table 26: Embedded PC CX20x0, installation position depending on the cooling option.

Embedded PCs	Horizontal installation position	Vertical and horizontal installation position
CX2020	X	-
CX2030	X	-
CX2040 with active cooling	X	X
CX2020 with CX2900-0200 fan option	X	X
CX2030 with CX2900-0200 fan option	X	X

Note the following specifications for the control cabinet:

- The Embedded PC should only be operated at ambient temperatures between -25 °C and 60 °C. Measure the temperature below the Embedded PC at a distance of 30 mm to the cooling fins, in order to determine the ambient temperature correctly.
- Adhere to the minimum distances of 30 mm above and below the Embedded PCs.
- Additional electrical equipment affects the heat generation in the control cabinet. Select a suitable control cabinet enclosure depending on the application, or ensure that excess heat is dissipated from the control cabinet.

#### Permitted installation position without fan

The Embedded PC must be installed horizontally on the mounting rail. Ventilation openings are located at the top and bottom of the housing. This ensures an optimum airflow through the Embedded PC in vertical direction. In addition, a minimum clearance of 30 mm above and below the Embedded PCs required, in order to ensure adequate ventilation.

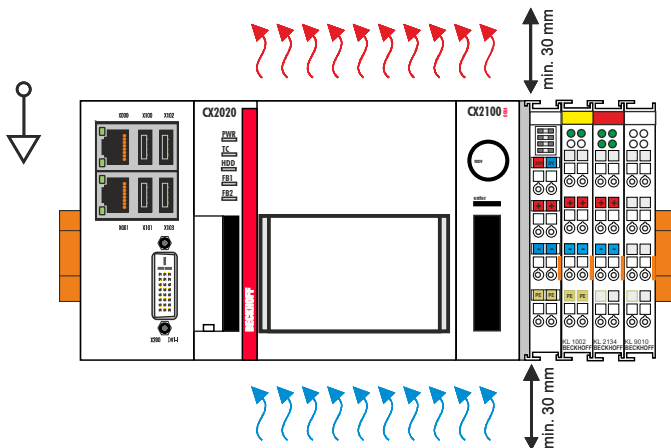

Fig. 22: Embedded PC CX20x0, horizontal installation position.

If vibrations and impact occurs in the same direction as the mounting rail, the Embedded PC must be secured with an additional bracket, in order to prevent it slipping.

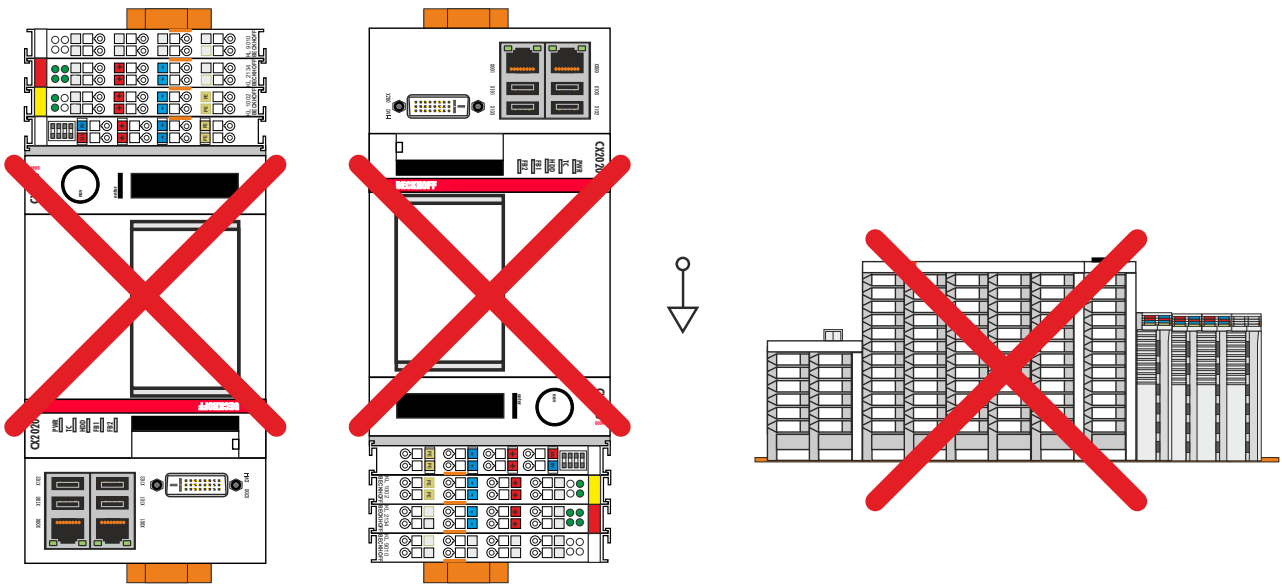

Fig. 23: Embedded PC CX20x0, unacceptable installation positions without fan.

**Permitted installation positions with fan**

Only Embedded PCs with an active cooling can be installed vertically or horizontally on the mounting rail. Without active cooling the Embedded PC is not ventilated adequately in vertical or horizontal position. In this case only the power supply units CX2100-0014 or CX2100-0914 should be used.

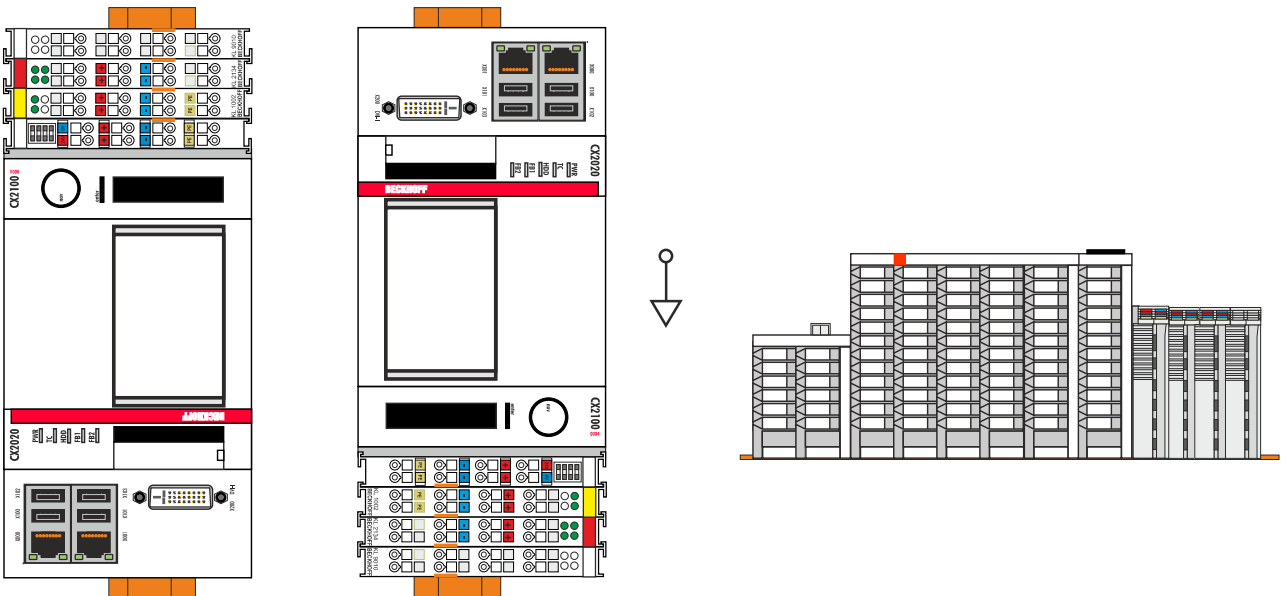

Fig. 24: Embedded PC CX20x0, permitted installation positions with fan.

Even with active cooling, the ambient temperature range between -25 and 60 °C and the minimum distances of 30 mm above and below the Embedded PC should be adhered to. Secure the Embedded PC with an additional bracket, in order to prevent it slipping from the DIN rail.

Ensure that Bus Terminals that are connected to the Embedded PC are designed for operation in vertical or horizontal position.

## 6.2.4 Attaching on mounting rail

The housing is designed such that the Embedded PC can be pushed against the mounting rail and latched onto it.

Requirements:

- Mounting rail of type TS35/7.5 or TS35/15 according to DIN EN 60715.

**Secure the Embedded PC on the mounting rail as follows:**

1. Unlock the latches at the top and bottom.

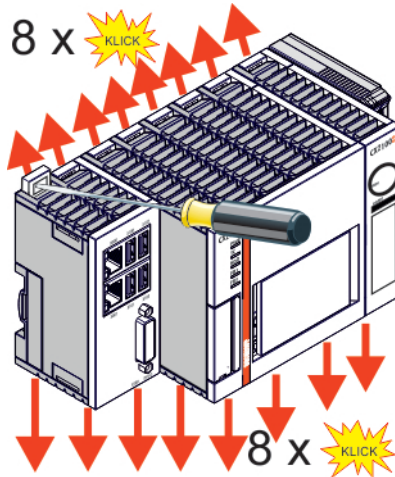

2. Place the Embedded PC at the front of the mounting rail. Slightly press the Embedded PC onto the mounting rail until a soft click can be heard and the Embedded PC has latched.

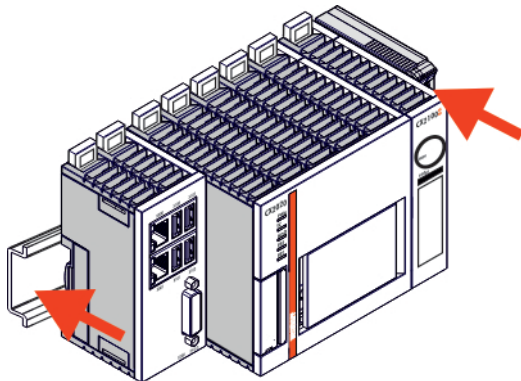

3. Then lock the latches again.

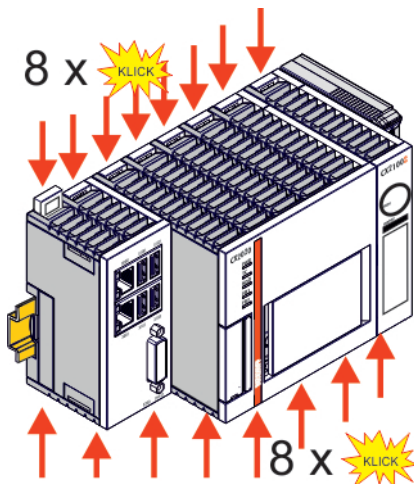

⇒ You have installed the Embedded PC successfully. Double-check the correct installation and latching of the Embedded PC on the mounting rail.

### 6.2.5 CFast card installation and removal

 <b>Note</b>	<p><b>Loss of data</b></p> <p>CFast cards are subjected to heavy load during operation and have to withstand many write cycles and extreme ambient conditions. CFast cards from other manufacturer may fail, resulting in data loss.</p> <p>Only use industrial CFast cards provided by Beckhoff.</p>
--	---

A CFast card is a non-volatile memory. Data to be retained in the event of a power failure should be saved on the CFast card. The CFast cards supplied by Beckhoff are industrial cards with an increased number of write cycles and an extended temperature range (+85 °C).

The eject mechanism is based on the push/push principle. The installation and removal of CFast cards is described below.

Requirements:

- The basic CPU module must be switched off. The CFast cards may only be installed or removed in switched off state.

#### Removing a CFast card

1. Gently push the CFast card.  
A soft click can be heard when the card is released.
2. The card is lifted by approx. 4 mm from the housing. Pull out the card.

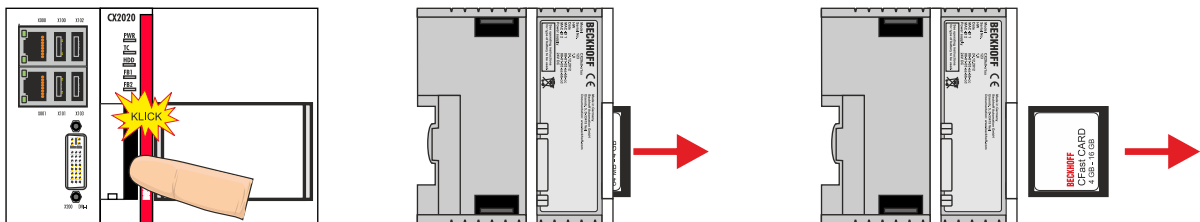

#### Installing a CFast card

1. Push the CFast card into the CFast card slot.

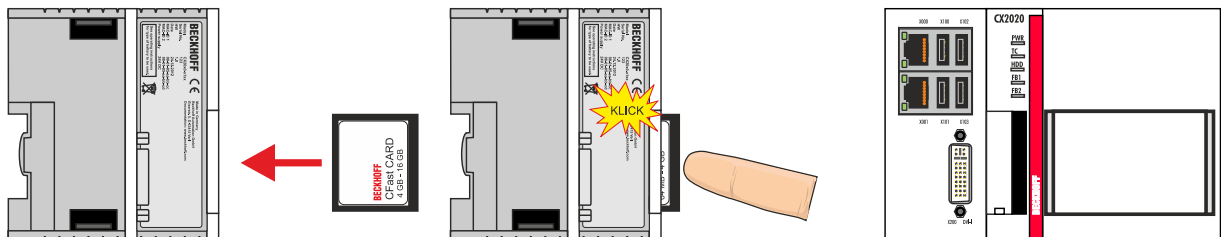

2. A soft click can be heard when the card engages.

⇒ The card is seated correctly if it is flush with the front side of the device housing.

## 6.2.6 Installing passive EtherCAT Terminals



**Note**

### Incorrectly installed passive EtherCAT Terminals

The E-bus signal between an Embedded PC and the EtherCAT Terminals can be impaired due to incorrectly installed passive EtherCAT Terminals.

Passive EtherCAT Terminals should not be installed directly on the power supply unit.

EtherCAT Terminals that do not take part in active data exchange are referred to as passive terminals. Passive EtherCAT Terminals have no process image and do not require current from the terminal bus (E-bus).

Passive EtherCAT Terminals (e.g. EL9195) can be detected in TwinCAT. In the tree structure the EtherCAT Terminal is displayed without process image, and the value in column "E-bus (mA)" does not change, compared to the preceding EtherCAT Terminal.

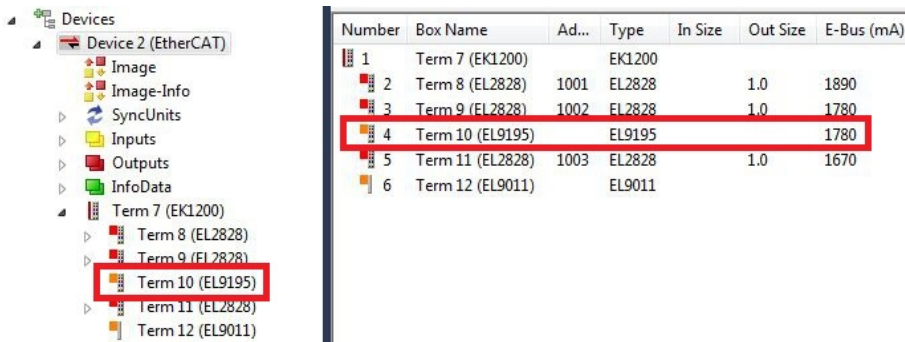

Fig. 25: Identifying a passive EtherCAT Terminal in TwinCAT.

The entry "Current consumption via E-Bus" in the technical data of an EtherCAT Terminal indicates whether a particular EtherCAT Terminal requires power from the terminal bus (E-bus).

The following diagram shows the permissible installation of a passive EtherCAT Terminal. The passive EtherCAT Terminal was not directly attached to the power supply unit.

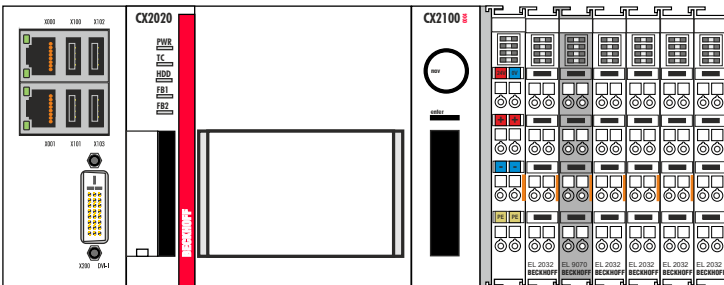

Fig. 26: Passive EtherCAT Terminals, permissible installation.

The following diagram shows the invalid installation of a passive EtherCAT Terminal.

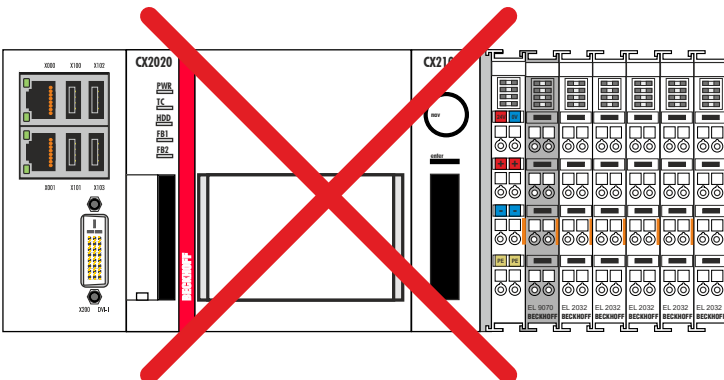

Fig. 27: Passive EtherCAT Terminals, invalid installation.

### 6.3 Connecting the power supply



Note

#### Damage to the Embedded PCs

The Embedded PCs may be damaged during wiring. The cables for the power supply should only be connected in de-energized state.

The CX2100-0xx4 power supply units require an external voltage source, which provides 24 V DC (-15% / +20%). The CX2100-0xx4 power supply units have to supply 4 A at 24 V, in order to ensure the operation of the basic CPU modules in all situations.

A 4 A fuse should be used for the power supply of the basic CPU module.

The cabling of the Embedded PC in the control cabinet must be done in accordance with the standard EN 60204-1:2006 PELV = Protective Extra Low Voltage:

- The "PE" and "0 V" conductors of the voltage source for a basic CPU module must be on the same potential (connected in the control cabinet).
- Standard EN 60204-1:2006, section 6.4.1:b stipulates that one side of the circuit, or a point of the energy source for this circuit must be connected to the protective earth conductor system.

#### Connection example with CX2020 basic CPU module and CX2100-0004 power supply unit:

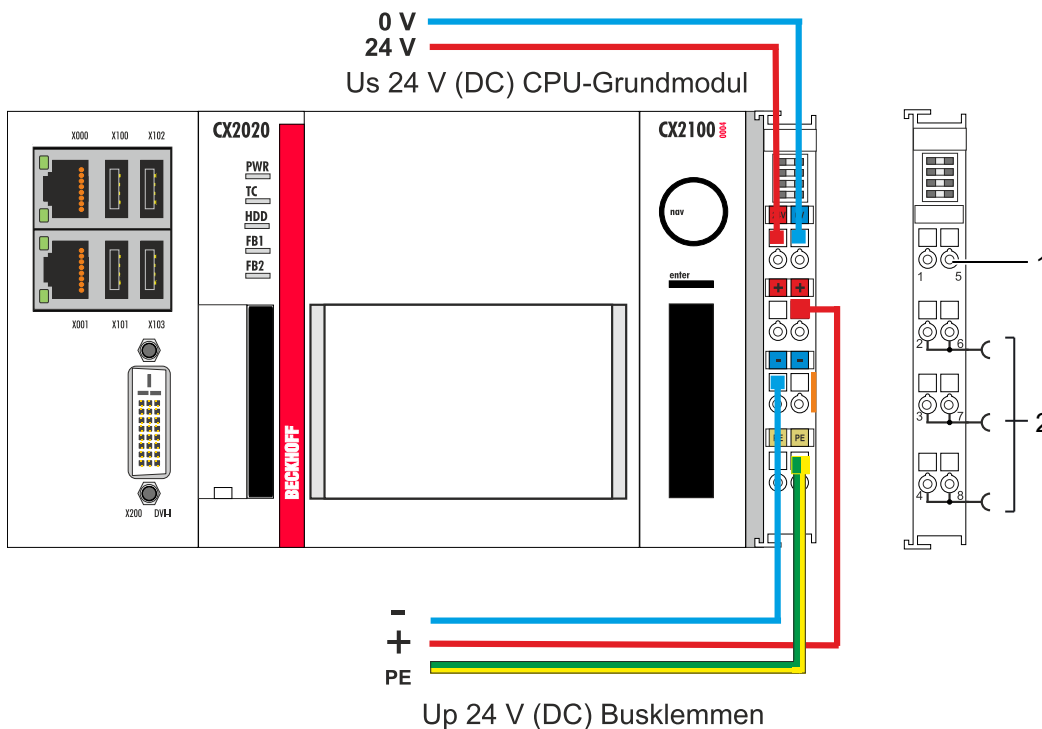



Table 27: Legend for the connection example

No.	Description
1	The upper spring-loaded terminals identified with "24 V" and "0 V" supply the basic CPU module and the terminal bus (data transfer via K- or E-bus).
2	The spring-loaded terminals identified as "+", "-", and "PE" supply the Bus Terminals via the power contacts and the sensors or actuators connected to the Bus Terminals.

	<p><b>Compliance with UL requirements:</b></p> <ul style="list-style-type: none"> <li>• The Embedded PCs must not be connected to unlimited voltage sources.</li> <li>• Embedded PCs may only be supplied from a 24 V DC voltage source. The voltage source must be insulated and protected with a fuse of maximum 4 A (corresponding to UL248).</li> <li>• Or the power supply must originate from a voltage source that corresponds to NEC class 2. An NEC class 2 voltage source must not be connected in series or parallel with another NEC class 2 voltage source.</li> </ul>
---	---

**Opening and closing spring-loaded terminals:**

The cables of an external voltage source are connected to the power supply unit with spring-loaded terminals. Connect the cables as follows:

Table 28: Required wire cross-sections and strip lengths

<b>Wire cross section</b>	0.5 ... 2.5 mm <sup>2</sup>	AWG 20 .. AWG 14
<b>Strip length</b>	8 ... 9 mm	0.33 inch

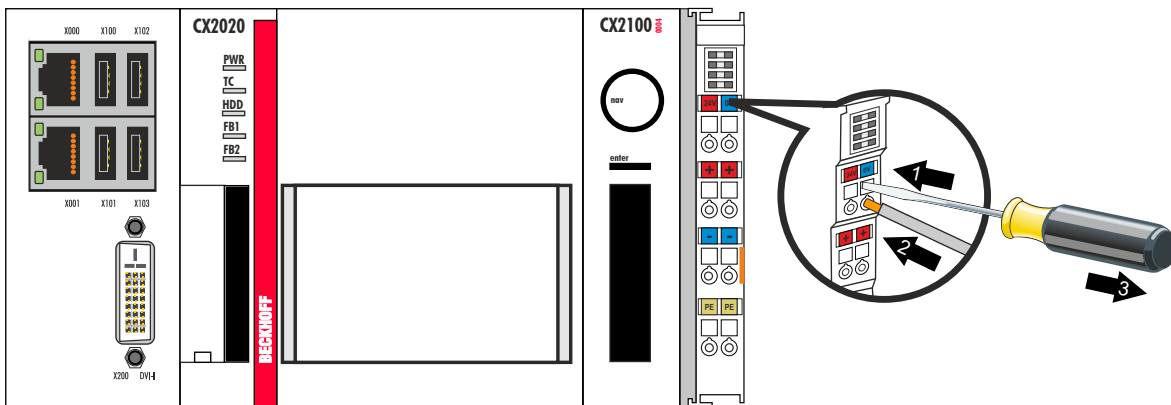



1. Open a spring-loaded terminal by slightly pushing with a screwdriver or a rod into the square opening above the terminal.
2. The wire can now be inserted into the round terminal opening without any force.
3. The terminal closes automatically when the pressure is released, holding the wire safely and permanently.

**Power supply unit LEDs**

The voltage sources have been connected to the power supply unit successfully when the two upper power supply terminal LEDs light up in green.

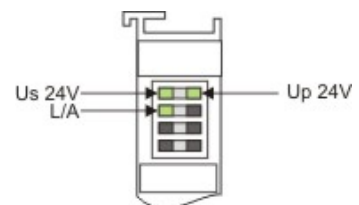
- The left LED (Us) indicates the supply of the basic CPU module and terminal bus.
- The red LED (Up) indicates the Bus Terminal supply via the power contacts.



 <p><b>Note</b></p>	<p><b>Interrupting / switching off the power supply</b></p> <p>To switch off the Embedded PC, do not disconnect the ground (0 V), because otherwise current may continue to flow via the shielding, depending on the device, and damage the Embedded PC or peripheral devices. Always disconnect the 24 V line. Devices connected to the Embedded PC, which have their own power supply (e.g. a Panel) must have the same potential for "PE" and "0 V" as the Embedded PC have (no potential difference).</p>
--	---



## 6.4 Switching on

Please ensure that the Embedded PC is fully configured before switching on the Embedded PC.

### Switch on the Embedded PC as follows:

1. Ensure that all extension, system and fieldbus modules are connected correctly.
  2. Check whether the right CX2100 power supply unit and the right installation position were selected.
  3. Check whether the Embedded PC is mounted securely on the DIN rail and all required Bus Terminals are connected.
  4. Only then switch on the power supply for the power supply unit.
- ⇒ The Embedded PC starts automatically when the external power supply is switched on. The pre-installed operating system is started and all connected extension, system and fieldbus modules are configured.

## 6.5 Switching off



Note

### Loss of data

If the Embedded PC is switched off during operation, data on the CFast card or other hard disks may be lost.

Do not disconnect the Embedded PC during operation.

### Switch off the Embedded PC as follows:

1. Stop all running programs properly, e.g. the control software on the Embedded PC.
2. Shut down the operating system.
3. Do not switch off the external power supply until all other tasks have been completed, in order to switch off the Embedded PC.

## 7 Configuration

### 7.1 Windows Embedded Compact 7

#### 7.1.1 Scan for new hardware

Under Windows Embedded Compact 7 the Embedded PC scans for new hardware on the PCI bus the first time it is started. After that the hardware is permanently registered and the saved configuration is used.

If other extension modules are plugged in after the first start, the Embedded PC no longer scans for new hardware and the new extension modules will not be found.

Follow these steps to ensure that an Embedded PC running Windows Embedded Compact 7 scans for new hardware again.

Requirements:

- Windows Embedded Compact 7

**Proceed as follows:**

1. Switch the Embedded PC off and remove the CFast card from the Embedded PC.
2. Insert the CFast card into an external card reader and open the CFast card's folder structure.
3. Delete the **Documents and Settings** folder on the CFast card.

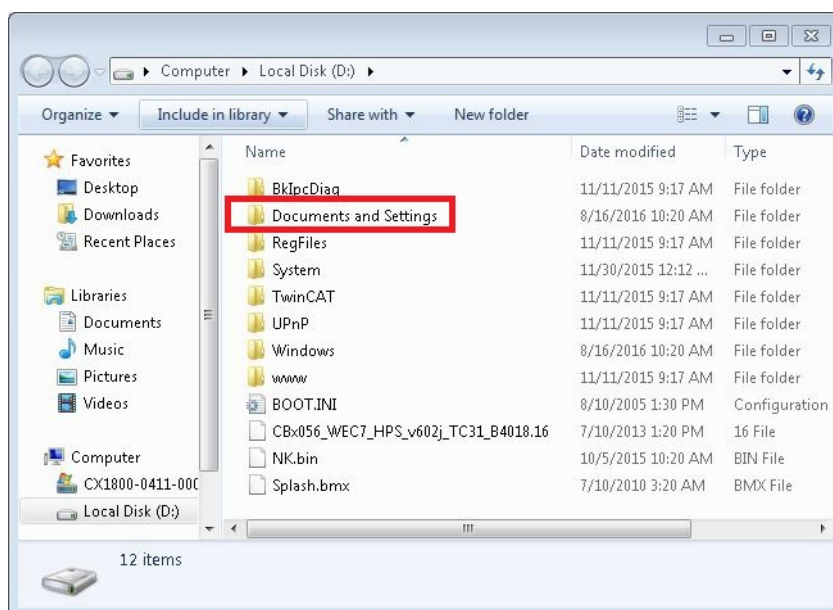

4. Install the CFast card in the Embedded PC again.
5. Start the Embedded PC.

⇒ After starting, the Embedded PC scans for new hardware once again and saves the current hardware configuration.  
As soon as you change the hardware and plug in other extension modules, you must repeat these steps and delete the **Documents and Settings** folder again.

## 7.2 Windows Embedded Standard 7 P

### 7.2.1 Identification of the Ethernet interfaces (X000, X001)

#### Network and Sharing Center

In the Network and Sharing Center the Ethernet interfaces (X000, X001) of the CX20x0 Embedded PC are identified as follows as standard:

- Local Area Connection 2 corresponds to Ethernet interface X000.
- Local Area Connection corresponds to Ethernet interface X001.

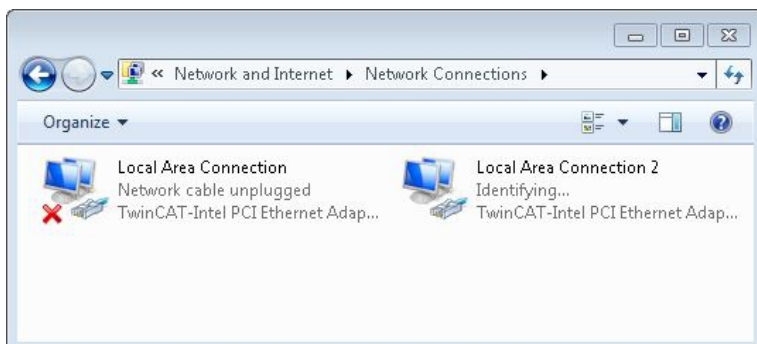

Fig. 28: Windows 7, Identification of the Ethernet interfaces (X000, X001) in the Network and Sharing Center.

#### Device Manager

In the Device Manager the Ethernet interfaces (X000, X001) of the CX20x0 Embedded PC are identified as follows as standard:

- TwinCAT Intel PCI Ethernet adapter (gigabit) #2 corresponds to the Ethernet interface X000.
- TwinCAT Intel PCI Ethernet adapter (gigabit) corresponds to the Ethernet interface X001.

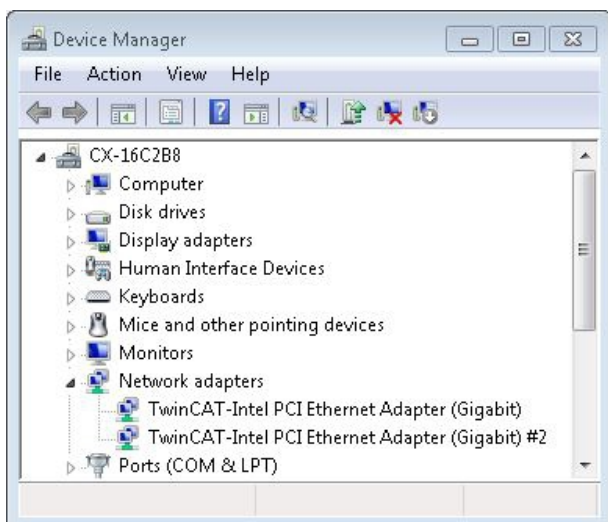

Fig. 29: Windows 7, identification of the Ethernet interfaces (X000, X001) in the device manager.

## 7.2.2 Enabling jumbo frames

Standardized Ethernet frames have a size of 1518 bytes. Ethernet frames that are larger than 1518 bytes are referred to as jumbo frames. Jumbo frames are used for transferring large data quantities. Jumbo frames are useful for certain applications, e.g. video cameras.

The Ethernet interfaces (X000, X001) support jumbo frames only if the original Intel® driver is installed.

Requirements:

- The original Intel® driver can be downloaded from <https://downloadcenter.intel.com>.
- Install the original Intel® driver. Note that this will delete the real-time capable driver from Beckhoff.
- Check whether the peripheral devices support jumbo frames.

**Jumbo frames are activated as follows:**

1. Under **Start > Control Panel > Hardware and Sound** click on **Device Manager**.
2. Double-click on the interface and then on the **Advanced** tab.

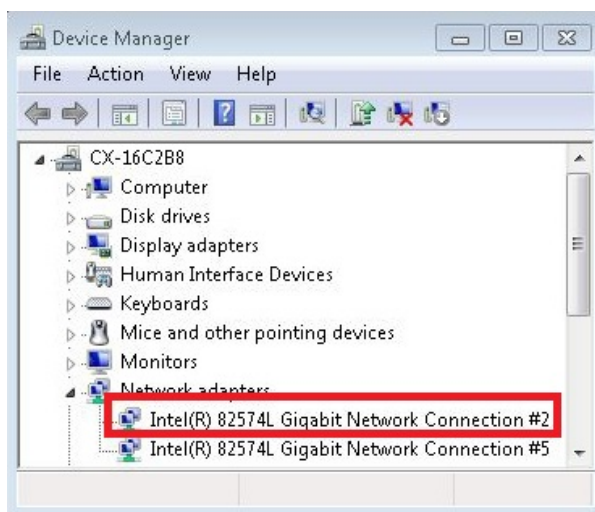

3. Under **Settings** click on Jumbo Packet, under **Value** select the option 4088 bytes or 9014 bytes.

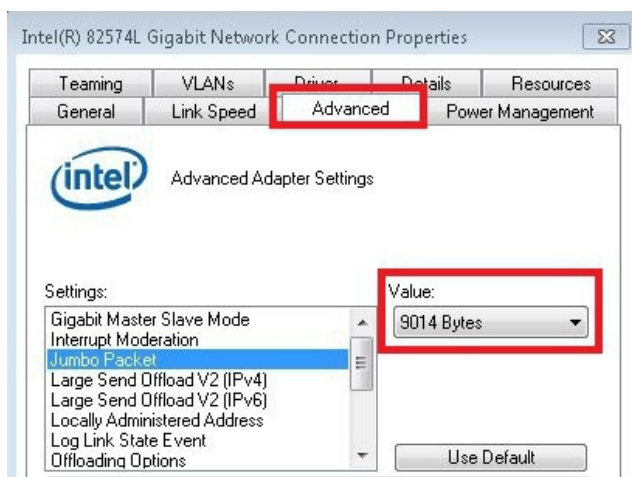

⇒ You have successfully activated jumbo frames, and you can now transfer larger data quantities.

### 7.2.3 Set NIC Teaming

NIC Teaming consolidates several physical network cards to group, thereby creating redundancy. Redundancy can help intercept interference in network cards or in the cabling by assigning the data transfer to other devices in the group.

Requirements:

- The original Intel® driver can be downloaded from <https://downloadcenter.intel.com>.
- Install the original Intel® driver for the Network Interface Card. Note that this will delete the real-time capable driver from Beckhoff.

**NIC Teaming is set as follows:**

1. Under **Start > Control Panel > Hardware and Sound** click on **Device Manager**.
2. Double-click on the interface.

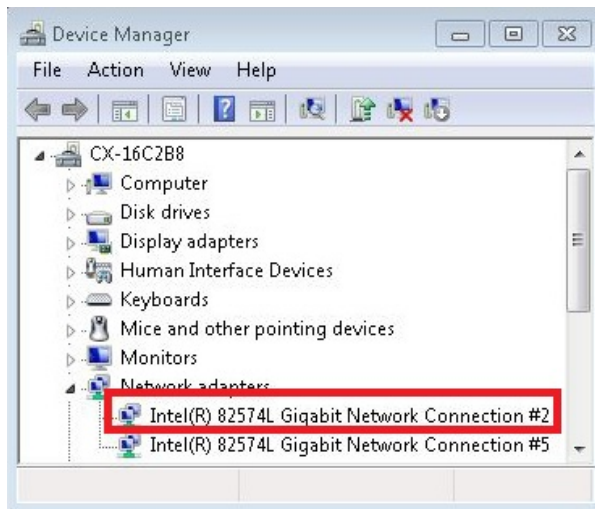

3. Click on the **Teaming** tab.
4. Click on **New Team** and follow the installation instructions.

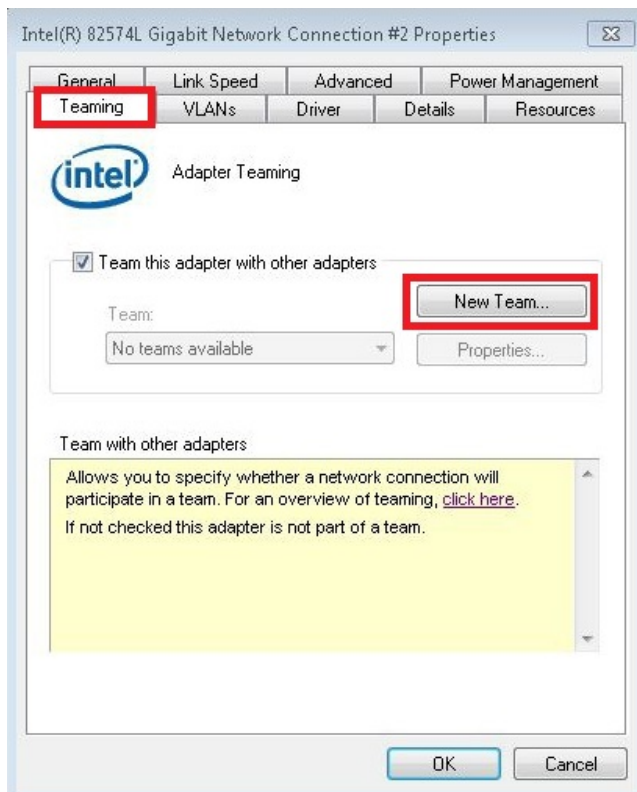

5. Under **Select a team type** select the option **Adapter Fault Tolerance**

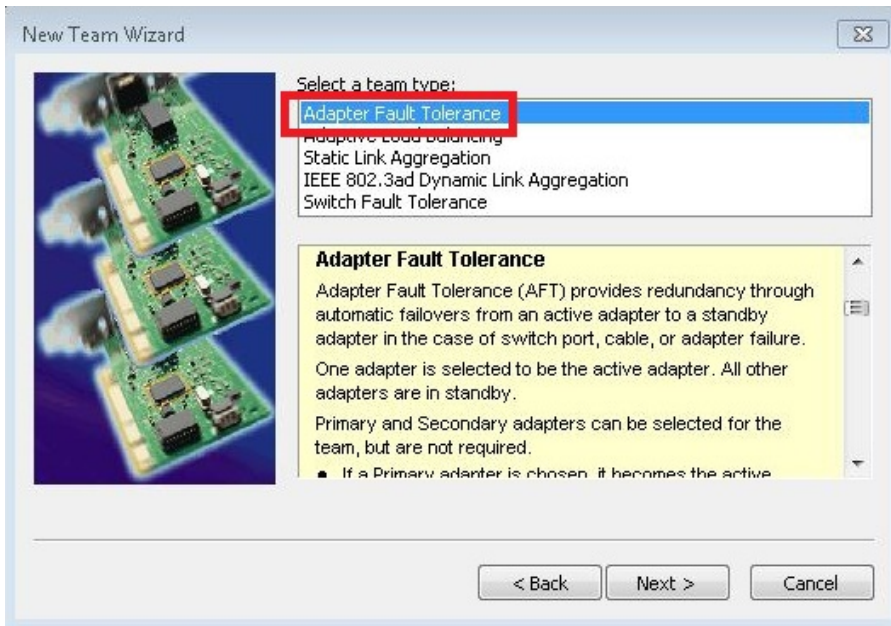

6. Click on **Next** to complete the installation.

⇒ You have successful set NIC Teaming for your Ethernet interfaces. Further settings can be specified or changed under the **Settings** tab.

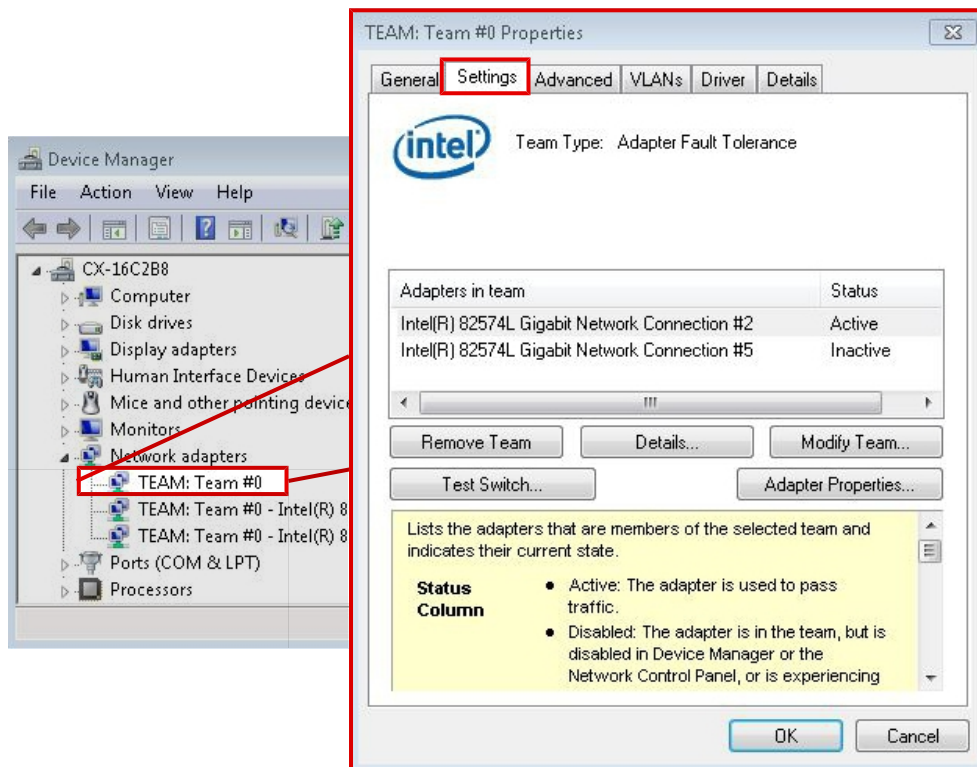



### 7.2.4 Restoring the Beckhoff real-time driver.

The Beckhoff real-time driver can be restored if the real-time driver was uninstalled or the original Intel® driver for jumbo frames or NIC Teaming was installed, for example. This chapter shows you how to use *TcRteInstall.exe* to restore the Beckhoff real-time driver. The file is in the TwinCAT directory by default.

Requirements:

- You can find the *TcRteInstall.exe* in a TwinCAT 2 standard installation under: *C:\TwinCAT\Io\TcRteInstall.exe*
- And in a TwinCAT 3 standard installation under: *C:\TwinCAT\3.1\System\TcRteInstall.exe*

Proceed as follows:

1. Double-click the *TcRteInstall.exe* file.

The installation dialog appears and shows the compatible Ethernet interfaces under **Compatible devices**.

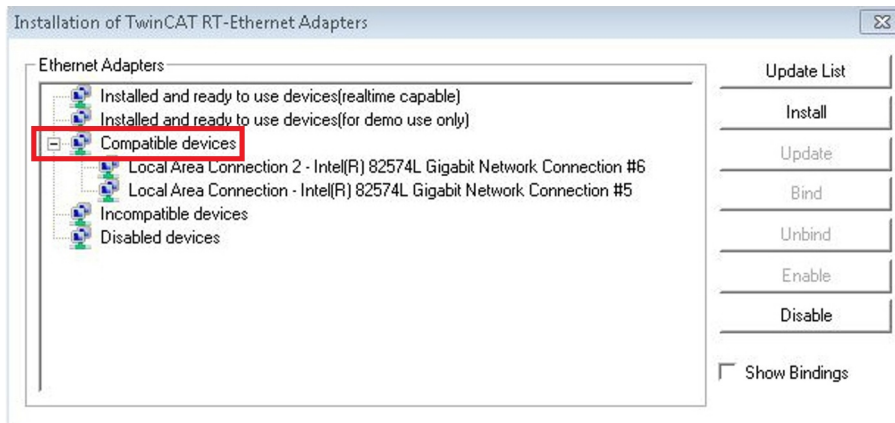

2. Select the Ethernet interfaces for which you wish to restore the Beckhoff real-time driver and click on **Install**.

⇒ The Beckhoff real-time driver is installed. The Ethernet interfaces with installed Beckhoff real-time driver are shown under **Installed and ready to use devices (real-time capable)**.

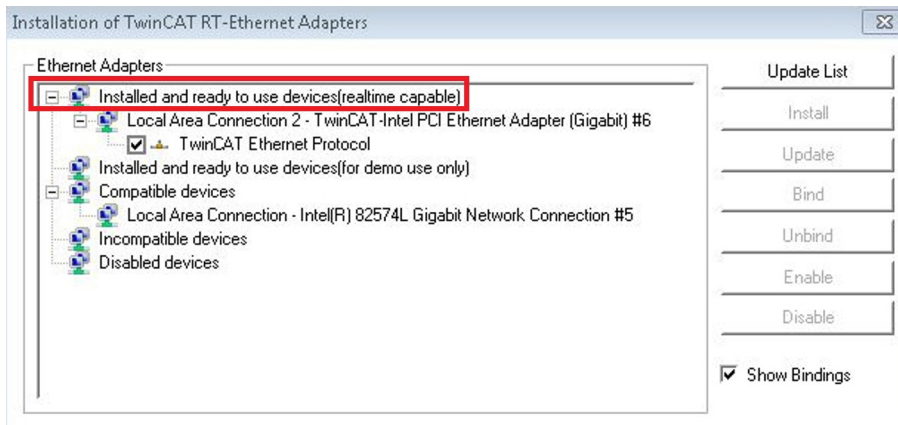

## 7.3 Windows 10 IoT Enterprise LTSB

### 7.3.1 Identification of the Ethernet interfaces (X000, X001)

#### Network and Sharing Center

In the Network and Sharing Center the Ethernet interfaces (X000, X001) of the CX20x0 Embedded PC are identified as follows as standard:

- Ethernet 2 corresponds to the Ethernet interface X000.
- Ethernet corresponds to the Ethernet interface X001.

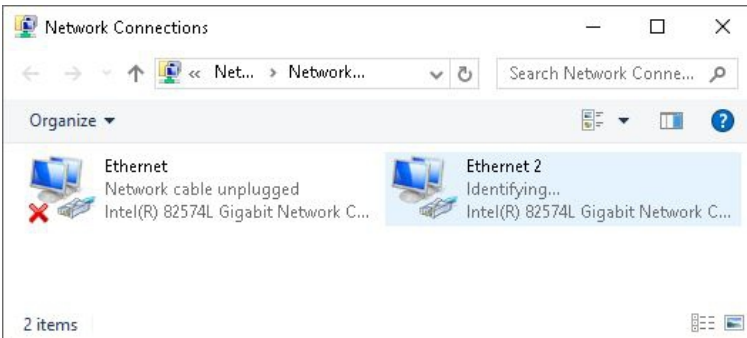

Fig. 30: Windows 10, Identification of the Ethernet interfaces (X000, X001) in the Network and Sharing Center.

#### Device Manager

In the Device Manager the Ethernet interfaces (X000, X001) of the CX20x0 Embedded PC are identified as follows as standard:

- Intel(R) 82574L Gigabit Network Connection #2 corresponds to the Ethernet interface X000.
- Intel(R) 82574L Gigabit Network Connection corresponds to the Ethernet interface X001.

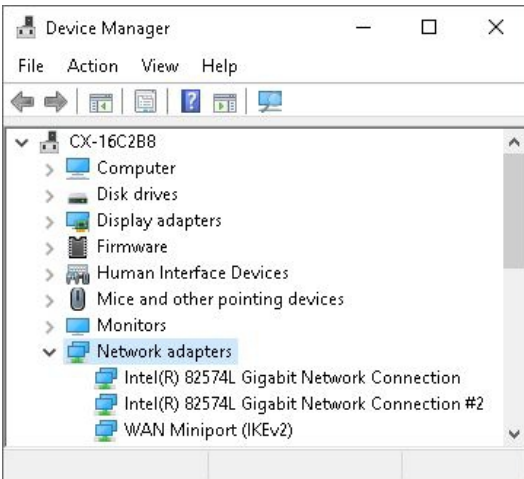

Fig. 31: Windows 10, identification of the Ethernet interfaces (X000, X001) in the device manager.



## 7.4 Beckhoff Device Manager

### 7.4.1 Starting the Beckhoff Device Manager

The Beckhoff Device Manager can be used to configure an Embedded PC with a web browser via a host PC. The Beckhoff Device Manager can also be used for diagnostic purposes.

Requirements:

- The host PC and the Embedded PC must be in the same network, and the network firewall must allow access via port 80.
- The IP address or the host name of the Embedded PC must be known.

Access to the Beckhoff Device Manager is protected. The access data differ depending on the operating system.

Table 29: Access data for the Beckhoff Device Manager on delivery.

Operating system	Access data
Windows Embedded Standard 7 P, Windows 10 IoT Enterprise LTSB	User name: Administrator Password: 1
Windows Embedded Compact 7	User name: Webguest Password: 1

Start the Beckhoff Device Manager as follows:

1. On the host PC enter the IP address or the host name of the Embedded PC in the web browser, in order to start the Beckhoff Device Manager  
 Example with IP address: **http://169.254.136.237/config**  
 Example with host name: **http://CX-16C2B8/config**
2. In the authentication window enter the user name and the password. The start page appears:

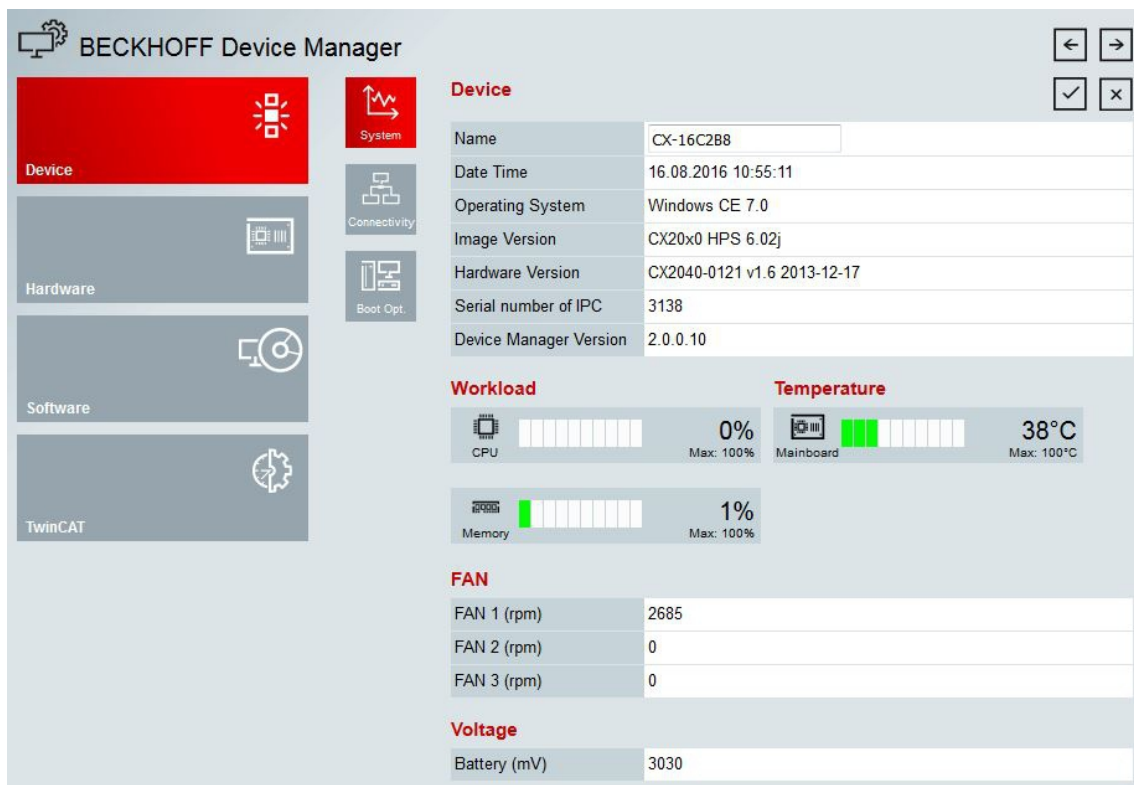

⇒ Continue to navigate in the menu and to configure the Embedded PC. Note that modifications only become active once they have been confirmed.

## 7.4.2 Enabling a remote display

In order to be able to access an Embedded PC with CE operating system via a remote display, a remote display has to be enabled first. Remote control of an Embedded PC with CE operating system from another PC requires an active remote display. The remote display is disabled as standard. This section illustrates how the remote display can be enabled with the Beckhoff device manager.

Requirements:

- The host PC and the Embedded PC must be in the same network, and the network firewall must allow access via port 80.
- The IP address or the host name of the Embedded PC must be known.

**Enable the remote display as follows:**

1. Enter the IP address or the host name of the Embedded PC in a web browser on the host PC.  
Example with IP address: **http://169.254.136.237/config**  
Example with host name: **http://CX-16C2B8/config**
2. In the authentication window enter the user name and the password for the Beckhoff Device Manager.  
The default settings are:  
User name: **Webguest**  
Password: **1**
3. In the menu under **Device** click on **Boot Opt.**

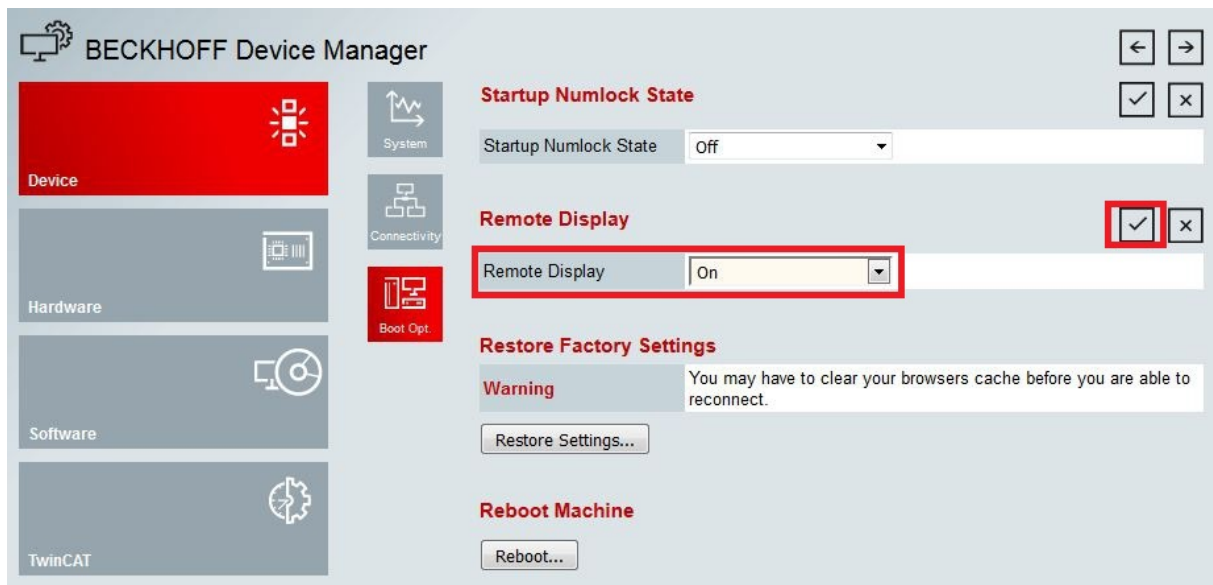

4. Under **Remote Display** select the option **On** and confirm the settings.
5. In the information window click **OK** to accept the settings.

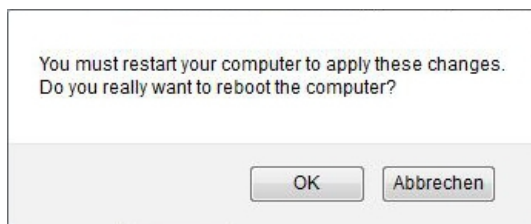

⇒ You have successfully activated the remote display on the Embedded PC. After a restart you can access your Embedded PC via remote display.

## 7.5 TwinCAT

### 7.5.1 Tree view

The Tree View chapter can be used as an example for creating a project without actual hardware. All devices and components of an Embedded PCs must be added manually in TwinCAT 3.

The smallest possible configuration of a CX20x0 Embedded PC, consisting of a basic CPU module and a CX2100-0004 power supply unit, is displayed in the tree view of TwinCAT 3 as follows:

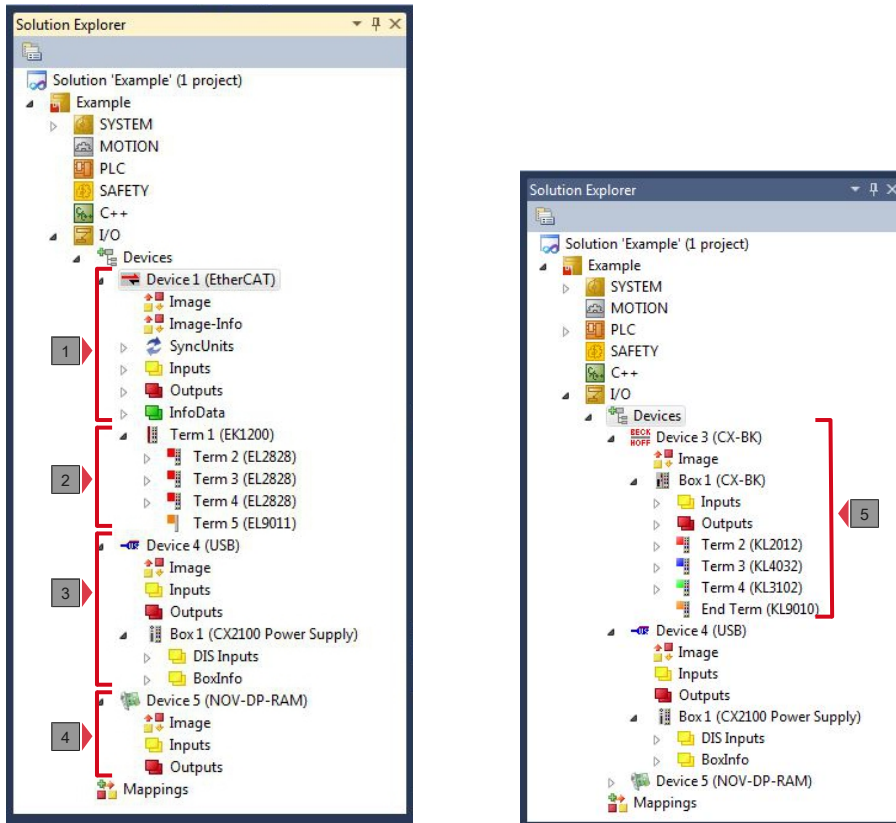

Fig. 32: CX20x0 Embedded PC in the tree view of TwinCAT 3, with attached EtherCAT Terminals (left) or Bus Terminals (right).

The configuration in the tree view differs depending on whether EtherCAT Terminals or Bus Terminals are connected to the Embedded PC.

Table 30: Legend for the tree view.

No.	Description
1	The CX20x0 Embedded PC with EtherCAT Terminals is added as EtherCAT master. Variables for diagnostic purposes are listed under inputs or outputs.
2	EtherCAT Terminals (E-bus) are displayed under the EK1200 Bus Coupler in the tree view.
3	The power supply unit for the CX20x0 Embedded PC appears under a USB device. The power supply unit also has variables for diagnostic purposes.
4	The CX20x0 features NOVDRAM for storing up to 128 kB of data securely. At this point the NOVDRAM handler is created, followed by configuration of the retain variables.
5	If Bus Terminals (K-bus) are used together with a CX20x0 Embedded PC, the Bus Coupler (CX-BK) is added together with the Bus Terminals.

## 7.5.2 Searching for target systems

Before you can work with the devices, you must connect your local computer to the target device. Then you can search for devices with the help of the IP address or the host name.

The local PC and the target devices must be connected to the same network or directly to each other via an Ethernet cable. In TwinCAT a search can be performed for all devices in this way and project planning subsequently carried out.

Prerequisites for this step:

- TwinCAT 3 must be in Config mode.
- IP address or host name of the device.

**Search for the devices as follows:**

1. In the menu at the top click on **File > New > Project** and create a new TwinCAT XAE project.
2. In the tree view on the left click on **SYSTEM**, and then **Choose Target**.

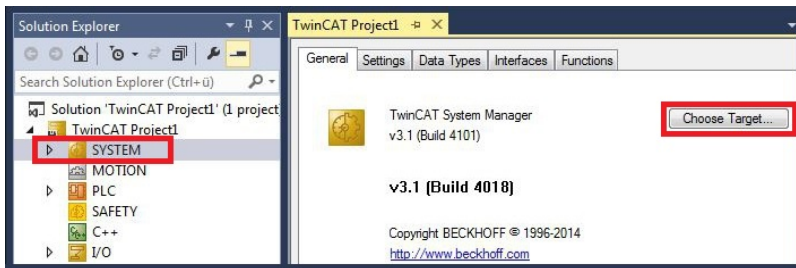

3. Click on **Search (Ethernet)**.

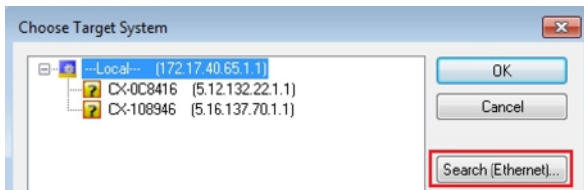

4. Type the host name or the IP address of the device into the **Enter Host Name / IP** box and press **[Enter]**.

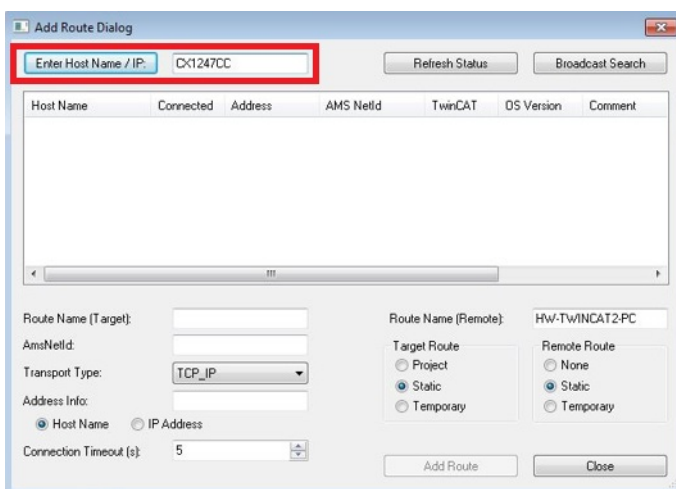

5. Mark the device found and click on **Add Route**.

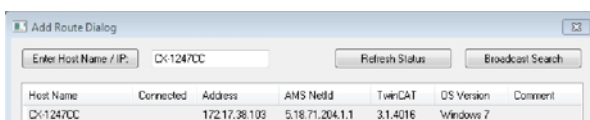

The Logon Information window appears.

Enter the user name and password for the CX in the **User Name** and **Password** fields and click **OK**.



The following information is set as standard in CX devices:

**User name:** Administrator **Password:** 1

6. If you do not wish to search for any further devices, click on **Close** to close the Add Route Dialog. The new device is displayed in the Choose Target System window.

7. Select the device you want to specify as target system and click **OK**.

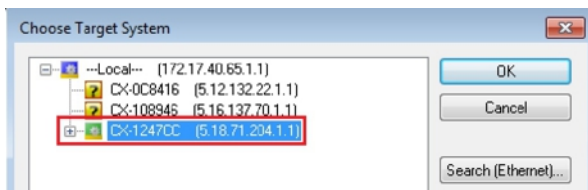

⇒ You have successfully searched for a device in TwinCAT and inserted the device as the target system. The new target system and the host name are displayed in the menu bar.



Using this procedure you can search for all available devices and also switch between the target systems at any time. Next, you can append the device to the tree view in TwinCAT.

### 7.5.3 Adding an Embedded PC

With this step you can add an Embedded PC in TwinCAT and then configure it.

Prerequisites for this step:

- A scanned and selected target device.

**Add the Embedded PC as follows:**

1. Start TwinCAT and open an empty project.
2. In the tree view on the left, right-click on **I/O Devices**.
3. In the context menu click on **Scan**.

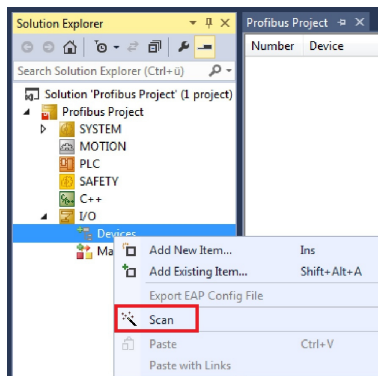

4. Select the devices you want to use and confirm the selection with **OK**. Only devices that are actual available are offered for selection.

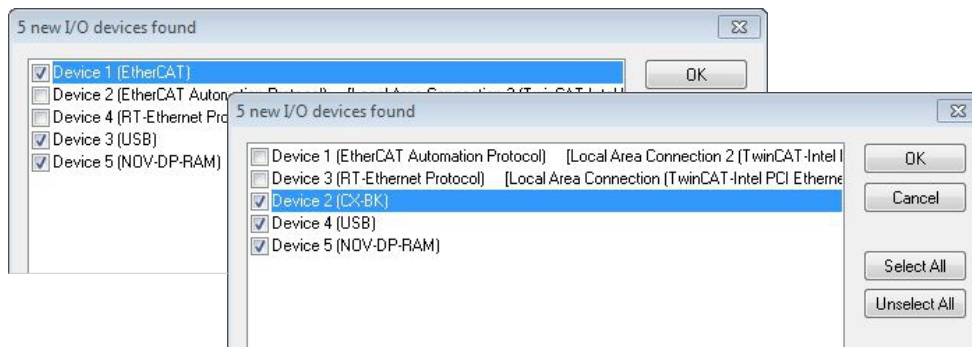

For Embedded PCs with connected Bus Terminals (K-bus) a Bus Coupler device (CX-BK) is displayed. For EtherCAT Terminals (E-bus) the EtherCAT coupler is added automatically.

5. Confirm the request with **Yes**, in order to look for boxes.
  6. Confirm the request whether to enable FreeRun with **Yes**.
- ⇒ The Embedded PC was successfully added in TwinCAT and is displayed in the tree view with the inputs and outputs.  
The Tree view chapter illustrates how Embedded PCs with connected Bus or EtherCAT Terminals are displayed.

### 7.5.4 Configuring EtherCAT cable redundancy.

The Embedded PC has two independent Ethernet interfaces, which can be used for EtherCAT cable redundancy. Cable redundancy offers resilience for the cabling. Interruptions of the EtherCAT communication due to broken wires or unplugged LAN cables are avoided.

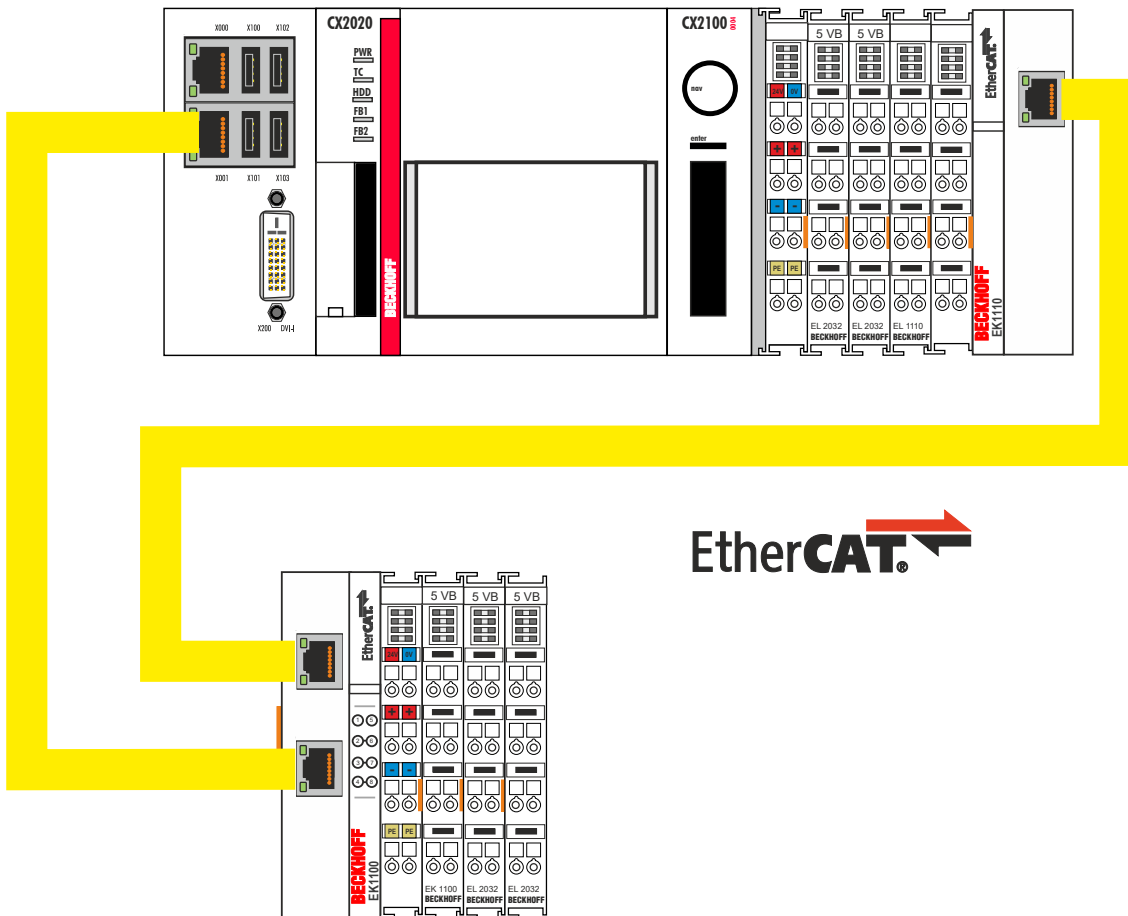

Fig. 33: Smallest possible configuration for EtherCAT cable redundancy.

Interference at the individual terminals is not intercepted by the cable redundancy.

Table 31: Cable redundancy, hardware for sample configuration.

Type	Description
CX2020 Embedded PC	Is the EtherCAT master in the example.
Bus Coupler EK1110	EtherCAT extension can be used to extend an EtherCAT segment by up to 100 m.
EK1100 Bus Coupler	The Bus Coupler relays the EtherCAT signal to connected EtherCAT Terminals.
EtherCAT Terminals	Any number of EtherCAT Terminals can be connected to the CX20x0 Embedded PC and the Bus Coupler.

Requirements:

- For TwinCAT 2 you have to install and license the supplement TS622x | TwinCAT EtherCAT Redundancy on the Embedded PC:  
<http://www.beckhoff.de/forms/twincat3/warenkorb.aspx?lg=de&title=TS622x-EtherCAT-Redundancy&version=1.0.2>
- In TwinCAT 3 the supplement is already included and only has to be licensed.
- Hardware wired as EtherCAT ring (see Fig.: Smallest possible configuration for EtherCAT cable redundancy) and added in TwinCAT.



**Configure EtherCAT cable redundancy as follows:**

1. In the tree view click on the EtherCAT master.

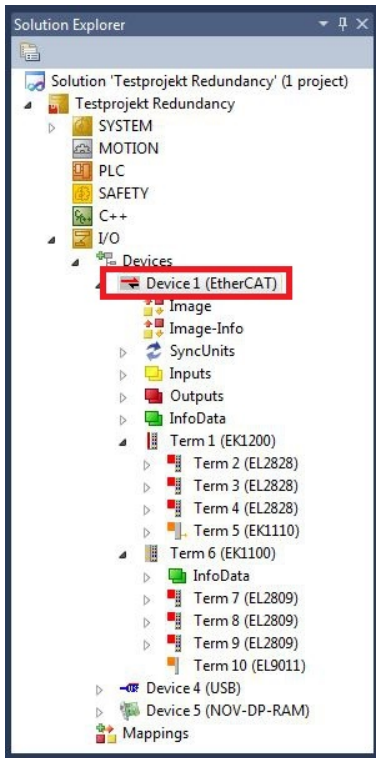

2. Click on the **EtherCAT** tab, then **Advanced Settings**.

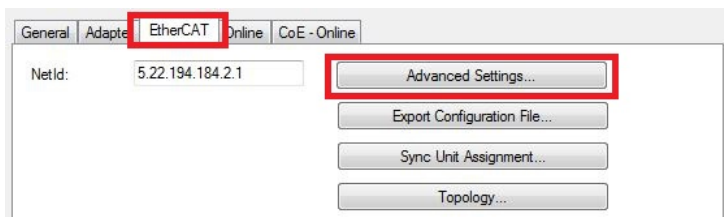

3. Click on **Redundancy** in the tree structure on the left.
4. Click on the option **Second adapter**, followed by the **Search** button.

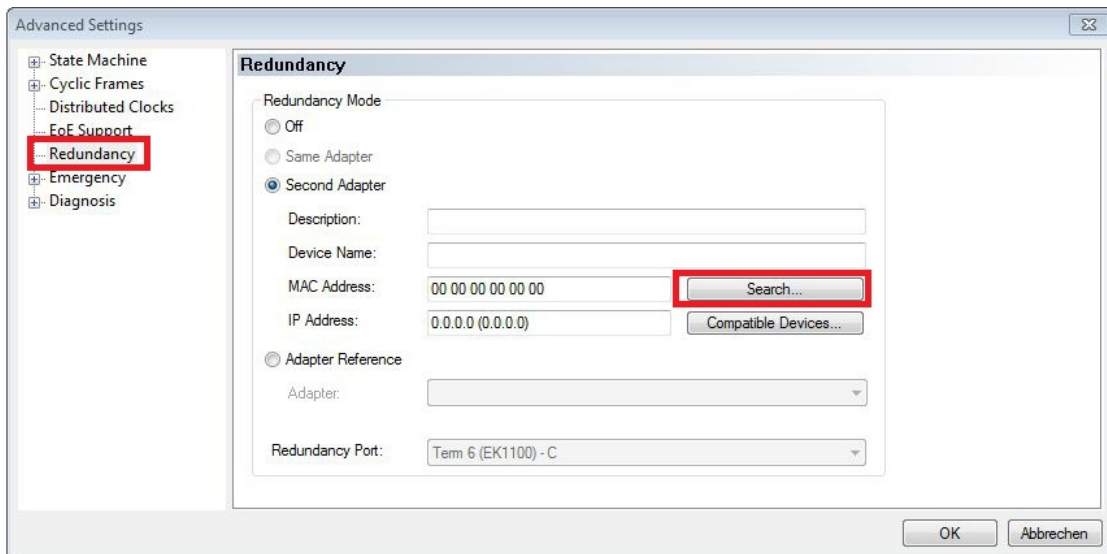



5. Select the appropriate LAN connection according to your cabling at the Embedded PC.

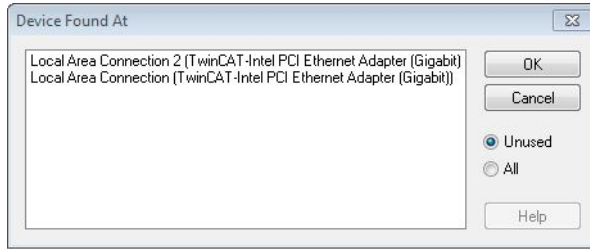

6. Confirm the settings with **OK**.

⇒ You have successfully configured cable redundancy. Under the **Online** tab the EtherCAT slaves are displayed, for which cable redundancy was configured.

Under **State** the state of the individual EtherCAT slaves is displayed. If, for example, the cable connection between the EK1100 and EK1110 Bus Couplers is interrupted, the status of the Bus Coupler changes. The message "LINK\_MIS B" and "LINK\_MIS A" appears under status.

No	Addr	Name	State	CRC
1	1001	Term 2 (EL2828)	OP	0, 0
2	1002	Term 3 (EL2828)	OP	0, 0
3	1003	Term 4 (EL2828)	OP	0, 0
4	1004	Term 5 (EK1110)	OP LNK_MIS B	0
5	1005	Term 6 (EK1100)	OP LNK_MIS A	0, 0, 0
6	1006	Term 7 (EL2809)	OP	0, 0
7	1007	Term 8 (EL2809)	OP	0, 0
8	1008	Term 9 (EL2809)	OP	0

Although the connection between the Bus Couplers is interrupted, the EtherCAT Terminals connected to the EK1100 Bus Coupler show no fault.

If the cable connection is interrupted without cable redundancy at the same location, the terminals show a fault under status.

No	Addr	Name	State	CRC
1	1001	Term 2 (EL2828)	OP	0, 0
2	1002	Term 3 (EL2828)	OP	0, 0
3	1003	Term 4 (EL2828)	OP	0, 0
4	1004	Term 5 (EK1110)	OP LNK_MIS B	0
5	1005	Term 6 (EK1100)	INIT NO_COMM	0, 0
6	1006	Term 7 (EL2809)	INIT NO_COMM	0, 0
7	1007	Term 8 (EL2809)	INIT NO_COMM	0, 0
8	1008	Term 9 (EL2809)	INIT NO_COMM	0

### 7.5.5 Using a hardware watchdog

The function block **FB\_PcWatchdog\_BAPI** activates a hardware watchdog on the Embedded PC. The watchdog can be used to automatically restart systems that have entered an infinite loop or where the PLC has stopped.

The watchdog is activated with **bExecute = TRUE** and **nWatchdogTimeS >= 1s**.

Once the watchdog has been activated, the function block must be called cyclically and at shorter intervals than **nWatchdogTimeS**, because the Embedded PC automatically restarts if the set time is less than **nWatchdogTimeS**.

 <b>Attention</b>	<p><b>Unwanted restart</b></p> <p>The watchdog restarts the Embedded PC as soon as the time set for nWatchdogTimeS elapses.</p> <p>Be aware of this behavior and disable the watchdog if you use breakpoints, carry out a PLC reset or an overall reset, stop TwinCAT, switch to config mode or activate the configuration.</p>
---	---

**Requirements:**

- Tc2\_System library.
- TwinCAT v3.1.0
- A previously created PLC project in TwinCAT.

**Locating the function block in TwinCAT:**

1. Double-click on **Tc2\_System** in the tree view under **PLC > PLC project > References**. The Library Manager appears.

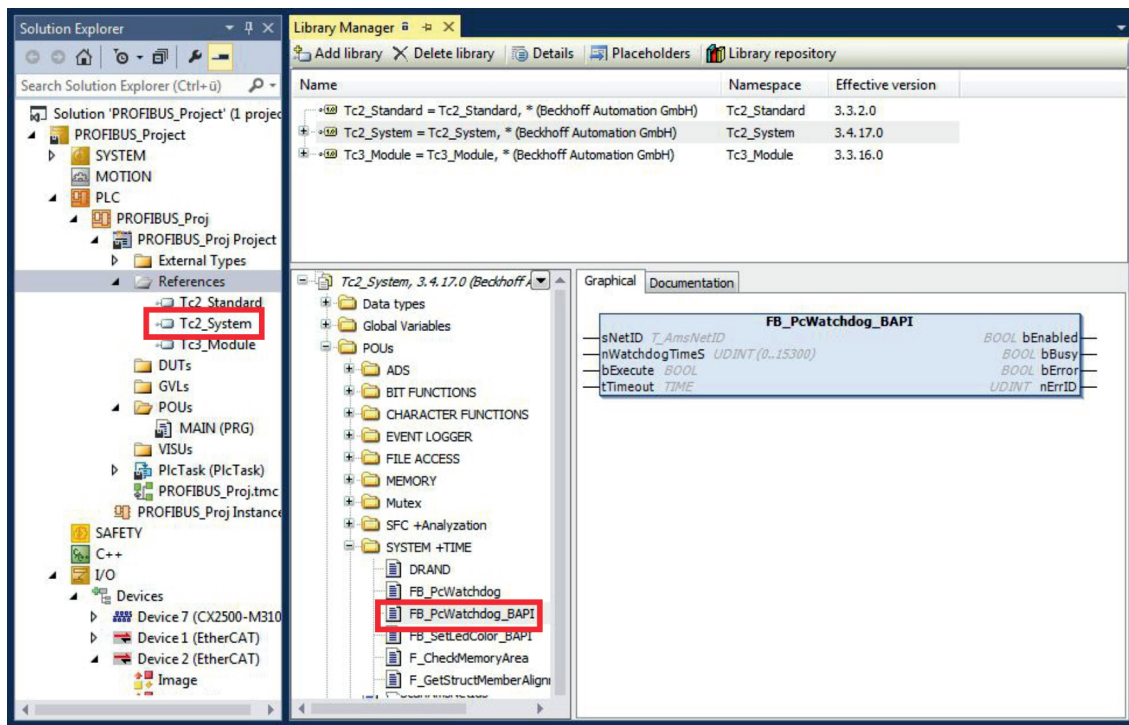

2. Under **Tc2\_System > POU's > SYSTEM +TIME** click on the function block **FB\_PcWatchdog\_BAPI**.

⇒ The description of the function block can then be found under the **Documentation** tab or in the library description under: **FB\_PcWatchDog\_BAPI**. If necessary, you can install the **Tc2\_System** library at a later stage via the **Add Library** button in the Library Manager.

## 8 NOVRAM

The NOVRAM can be used to reliably save important variable values, such as production data or counter values, in the event of a power failure. The memory size of the NOVRAM is limited and only suitable for smaller data quantities up to 63 kB.

This chapter illustrates how the NOVRAM is

- used in TwinCAT 3 (see: [Use under TwinCAT 3 \[▶ 58\]](#)).

### Functioning

The NOVRAM (Non-Volatile Random Access Memory) is a special memory component that is used to reliably save important data. The NOVRAM consists of two sections, a volatile memory and a non-volatile memory.

TwinCAT only writes to the volatile section of the NOVRAM. In the event of a power failure, the data are automatically copied from the volatile memory into the non-volatile memory. The energy required for this process is supplied by a capacitor. As soon as the power supply is restored, the data are automatically copied back into the volatile memory, so that TwinCAT can continue to use them.

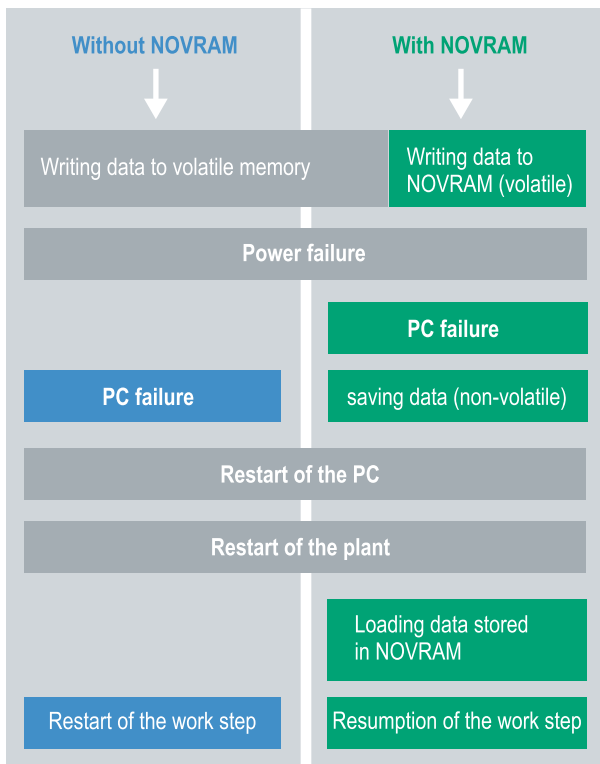

Fig. 34: Controller behavior with and without NOVRAM.

### Memory size

The NOVRAM has a capacity of 128 kB. However, for reasons of data consistency, effectively less than 63 kB of data can be securely saved in the NOVRAM. The data are saved cyclically and alternately based on the dual buffer principle, in order to avoid the risk of data inconsistency.

### Requirements

Development environment	Target platforms	Hardware	PLC libraries to include
TwinCAT 3.1 Build: 4020	PC or CX (x86, x64, ARM)	CX9020, CX20x0, CX20x2	Tc2_IoFunctions

## 8.1 Use under TwinCAT 3

Under TwinCAT 3 (from Build 4020) a delta algorithm is used to save data in the NOVRAM. The algorithm does not save all the variables in the NOVRAM. Instead, it searches for changes (delta function) compared to the previous cycle and only saves variables that have changed.

To use the delta algorithm, a Retain Handler must be created in TwinCAT 3, and the relevant variables must be declared in the PLC with the keyword `VAR_RETAIN`.

A new feature of this method is that no function blocks have to be used. The Retain Handler saves data in the NOVRAM in the event of a power failure and makes them available again once the power has been restored.

### 8.1.1 Creating a Retain Handler

This chapter describes how to create a Retain Handler in TwinCAT 3. The Retain Handler saves data in the NOVRAM and makes them available again. In other words, important variable values such as production data or counter values are retained during a restart or power failure.

Prerequisites for this step:

- TwinCAT 3.1 Build: 4020.
- A target device selected in TwinCAT.

**Create the Retain Handler as follows:**

1. Right-click on **Devices** in the tree view on the left-hand side.
2. In the context menu click on **Scan**.

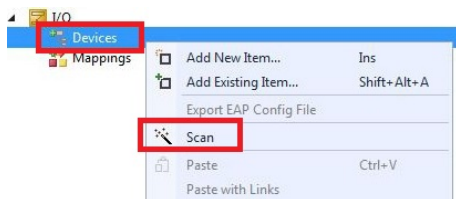

3. Select **Device (NOV-DP-RAM)** and confirm with **OK**.

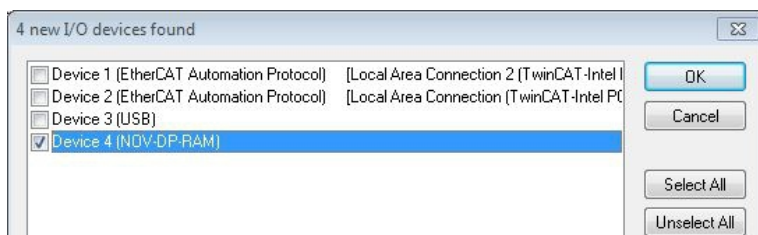

4. Click on **Yes** to search for boxes.

- Click on **Device (NOV-DP-RAM)** in the tree view on the left-hand side and then on the tab **Generic NOV-DP-RAM Device**.

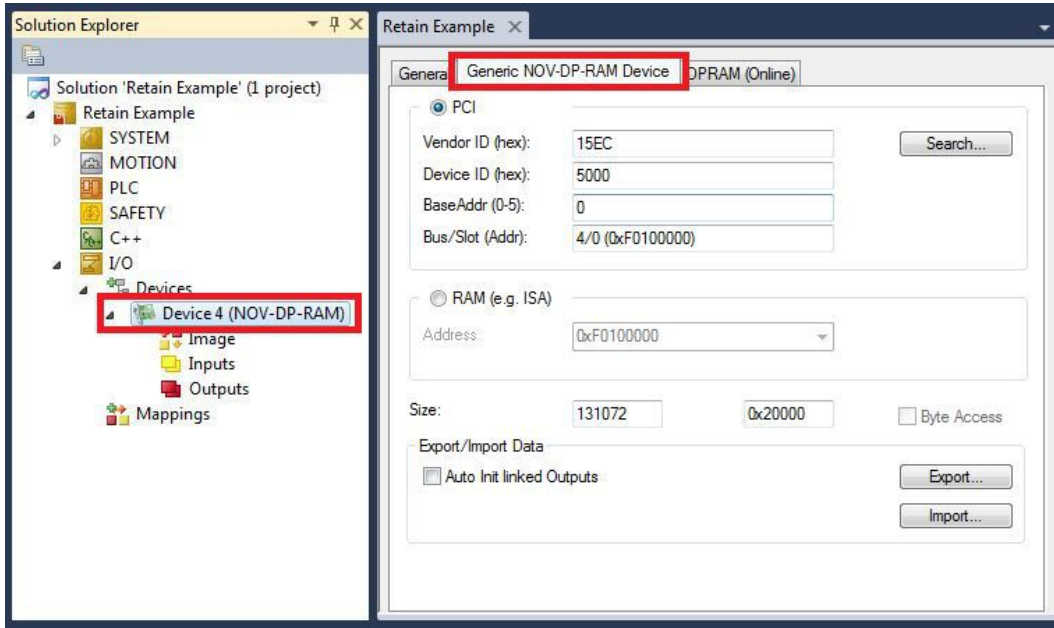

- Click on the option **PCI**.
- Right-click on **Device (NOV-DP-RAM)** in the tree view and then on **Add New Item**.

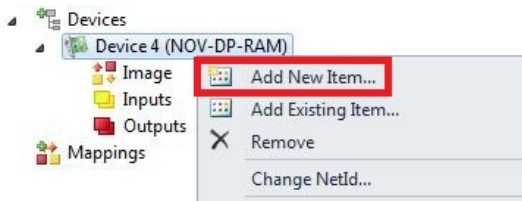

- Select the **Retain Handler** and click on **OK**.



⇒ You have successfully created a Retain Handler in TwinCAT.

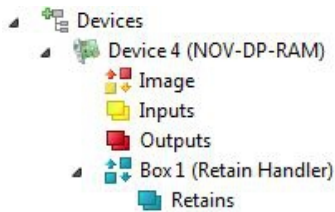

In the next step you can create retain variables in the PLC and link them with the Retain Handler.

## 8.1.2 Creating and linking variables

Once you have created a Retain Handler in TwinCAT, you can declare variables in the PLC and link them to the Retain Handler. The variables have to be identified in the PLC with the keyword VAR\_RETAIN.

Prerequisite for this step:

- A PLC project created in TwinCAT.

**Create variables as follows:**

1. Create the variables in your PLC project in a VAR\_RETAIN area.

```

1  PROGRAM MAIN
2
3  VAR_RETAIN
4      x      :UINT;
5      y      :UINT;
6      z      :UINT;
7  END_VAR
8
9  VAR
10
11     datain  AT%I*: REAL;
12     dataout AT%Q*: BYTE;
13
14  END_VAR

```

2. Click on **Build** in the toolbar at the top, then on **Build Solution**.

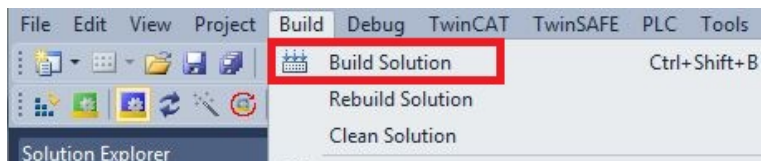

3. Click on **PLC Instance** in the tree view on the left and then on the tab **Data Area**.

The image shows the TwinCAT interface. On the left, the 'Solution Explorer' tree view shows the project structure. The 'RetainPLC Instance' folder is selected and highlighted with a red box. On the right, the 'Data Area' tab is active, showing a table of variables. The 'Data Area' tab is also highlighted with a red box.

Ar...	Name	Type	S...	CS	Ele...	Retain Hdl	Ow...	Co...
+ 0 (0)	PlcTask Inputs	Input...	5...	✓	1 Sy...			
+ 1 (0)	PlcTask Outputs	Outp...	5...	✓	4 Sy...			
+ 3 (0)	PlcTask Internal	Inter...	5...	✓	12 S...			
- 4 (0)	PlcTask Retains	Retai...	5...	✓	3 Sy...	00000000		
	MAIN.x	UINT	2...					
	MAIN.y	UINT	2...					
	MAIN.z	UINT	2...					



4. Under **Retain Hdl**, select the Retain Handler that you have created.

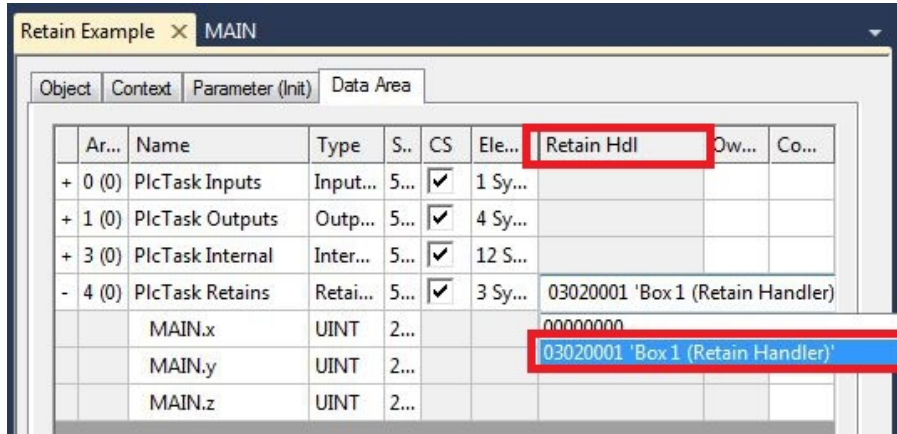

⇒ After selecting a Retain Handler as a target, the symbols in the tree view are linked and a mapping is created.  
 In the tree view the variables are created from the PLC under the Retain Handler and linked to the variables from the PLC instance.

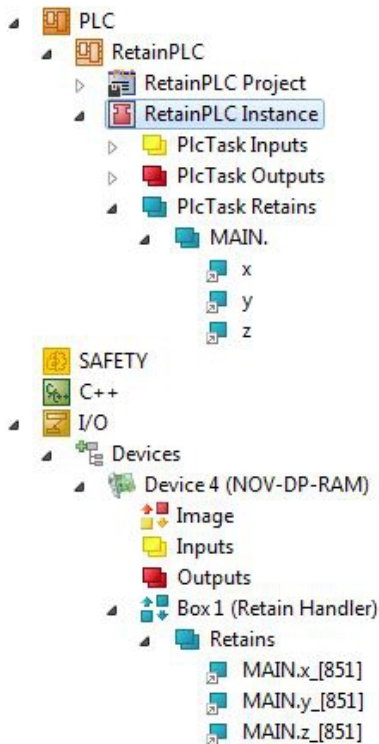

An existing link is displayed with an arrow symbol.

### 8.1.3 Note the write speed of the Retain Handler

The Retain Handler takes a certain amount of time to search for changes (delta function) in the variables and save them in the NOVRAM.

The following diagrams provide an overview of how long the Retain Handler needs to save a particular data quantity in the NOVRAM. Use the diagrams to select your task cycle time such that a particular data quantity is saved in the NOVRAM within the selected task cycle time.

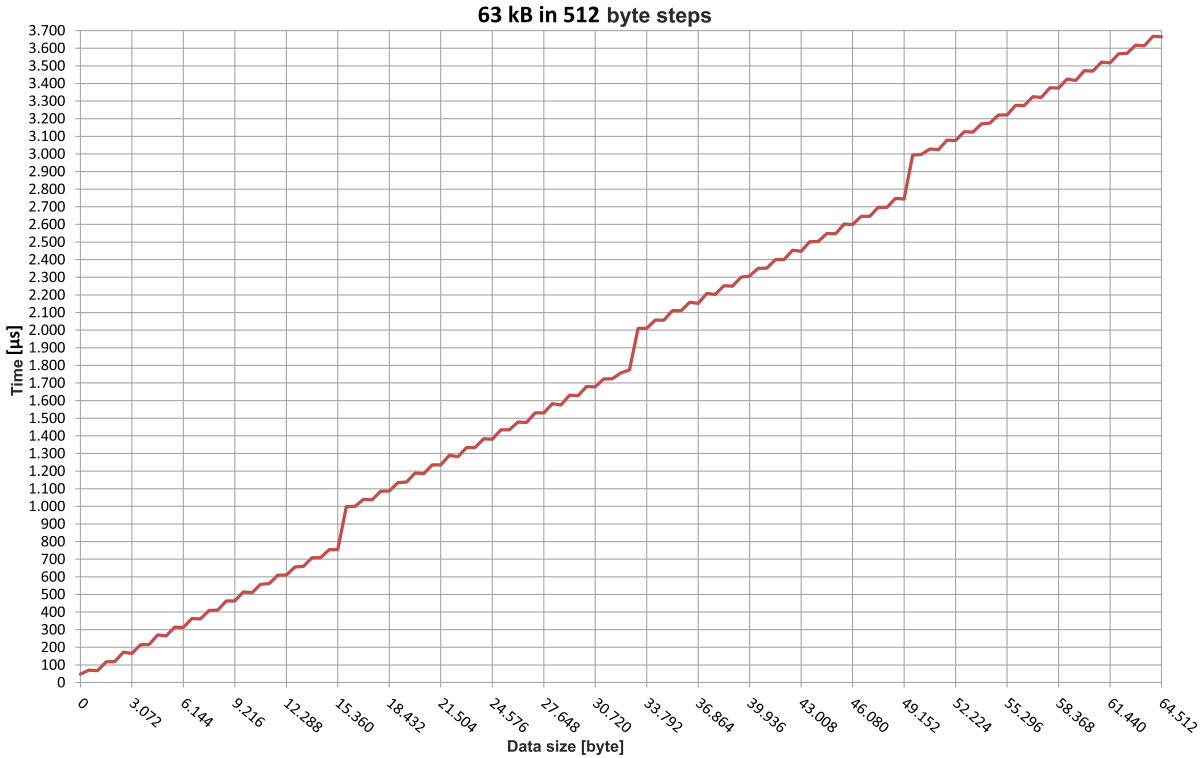

Fig. 35: Retain Handler write speed, up to 63 kB in 512 byte steps.

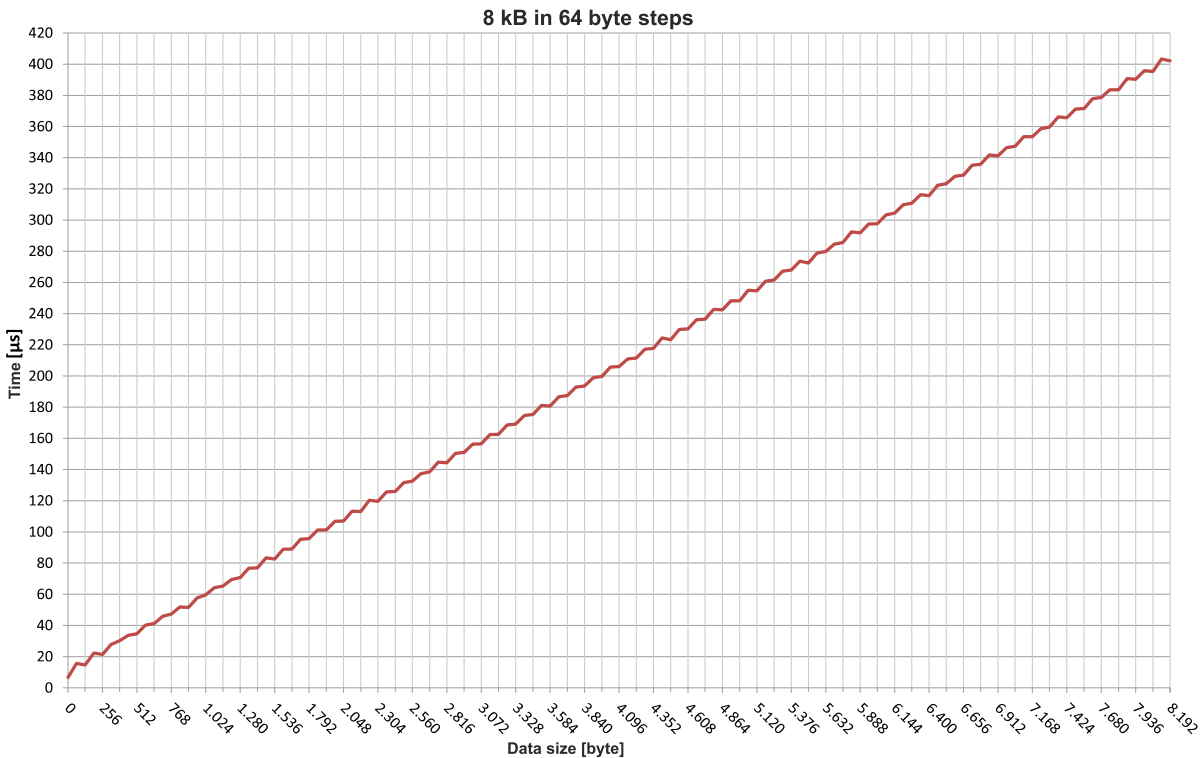

Fig. 36: Retain Handler write speed, up to 8 kB in 64 byte steps.



### 8.1.4 Deleting variables under the Retain Handler

If variables are deleted from the PLC, the link with the Retain Handler is cancelled. However, the variables continue to be shown under the Retain Handler and are not deleted automatically.

Under TwinCAT 3 the variables have to be deleted manually.

Prerequisites for this step:

- Variables declared with VAR\_RETAIN were deleted from the PLC.

Delete the variables under the Retain Handler as follows:

1. The variable GVL\_Retain.iNt under the Retain Handler is to be deleted.

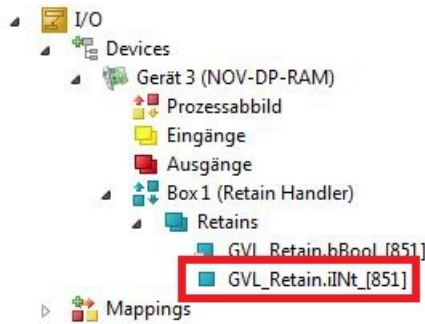

2. Right-click on the **Retain Handler** in the tree view on the left.
3. In the context menu click on **Optimize Retain Variables**.

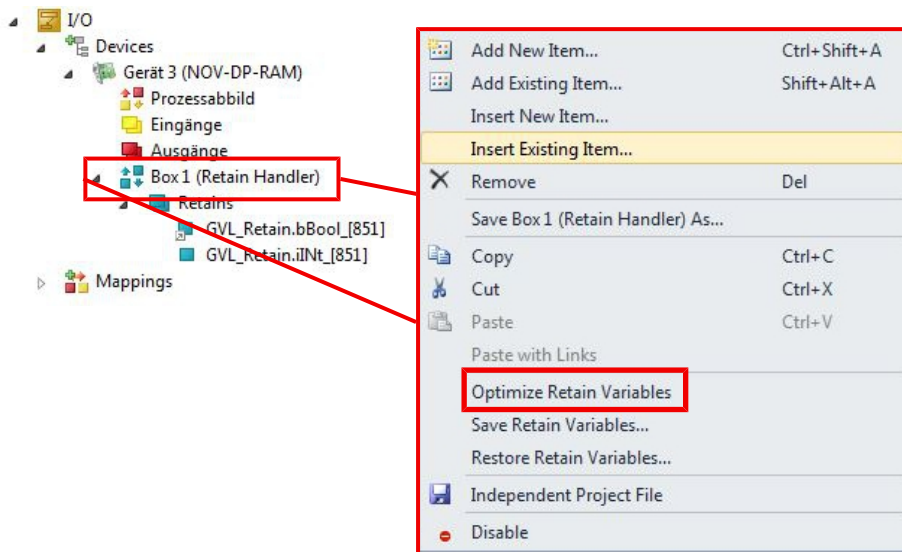

⇒ The variable under the Retain Handler is deleted.

## 9 UPS (persistent data)

If the power supply fails, the UPS continues to supply the Embedded PC. During this period persistent data can be saved, which are available on switching on again. Use a UPS to shut down the Embedded PC in a controlled manner and to save persistent data.

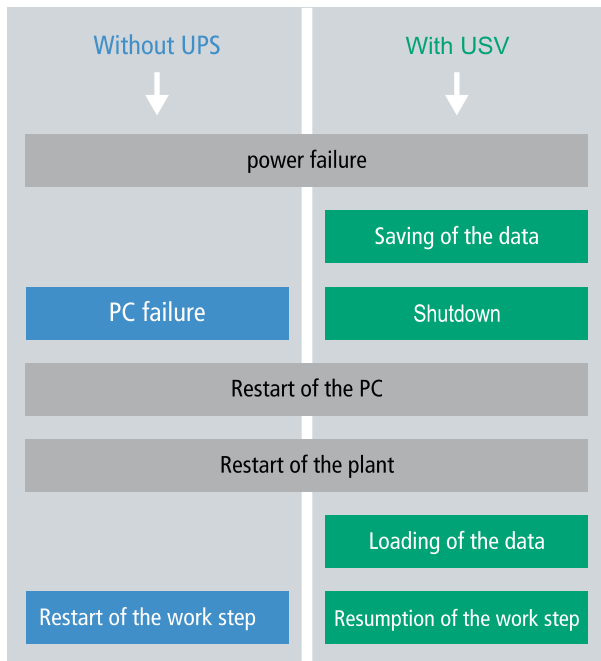

The following UPS configurations can be used:

- CX2100-0904, power supply unit with integrated capacitive UPS.
- CX2100-0914 power supply unit and CX2900-0192 battery pack.

### Storage location and names of the files:

The persistent data are saved by default in the TwinCAT boot directory:

Development environment	File path	File name
TwinCAT 2	C:\TwinCAT\Boot\	TCPLC_T_x.wbp TCPLC_T_x.wb~ (Backup) The x in the file name stands for the number of the runtime system.
TwinCAT 3	C:\TwinCAT\3.1\Boot\	Port_85x.bootdata Port_85x.bootdata-old (backup) The x in the file name stands for the number of the runtime system.

Configure the CX20x0 as follows in order to save persistent data:

- First of all you have to configure the UPS. Read how to do this in the relevant chapter of the CX2100-09x4 power supply documentation.  
<https://download.beckhoff.com/download/document/ipc/embedded-pc/embedded-pc-cx/cx2100-09x4de.pdf>
- Configure the Windows write filter and issue the corresponding write permissions in order to be able to save persistent data (see: [Windows write filter](#) [▶ 65]).
- Declare important data such as counter values in the PLC as VAR PERSISTENT.
- Subsequently you can check the validity of the variables and monitor whether the persistent data are loaded without error (see: [Checking the validity of the variables](#) [▶ 66]).

Components	Version
TwinCAT on the development PC and on the control system	TwinCAT 2.11R3 Build 2047 (or higher) TwinCAT 3.1 Build 4018 (or higher)

## 9.1 Windows write filter

Since the persistent data are stored on a storage medium, the file and the path must be writeable. If you use the Windows write filter, the Windows partition is protected against write access operations, and the persistent data are not saved.

- Switch off the EWF, if you want to save persistent data.
- The FBWF and UWF do not have to be switched off, because an exception can be defined for the directory \Boot.

For Windows CE and Windows Embedded Compact 7 no Windows write filters are used.

### FBWF exception list

By default an exception list is automatically created when the FBWF is switched on. The \Boot directory is already entered in this list. Check the configuration of the FBWF if you have made changes to the exception list.

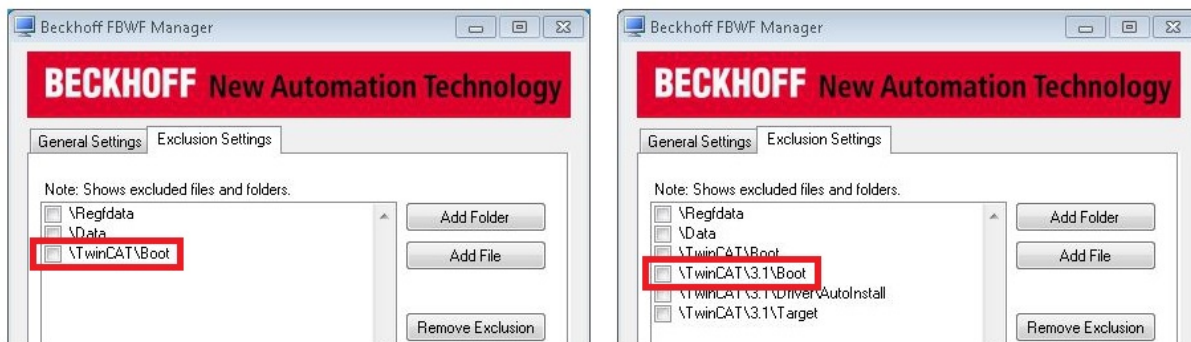

Fig. 37: FBWF exception list, under TwinCAT 2 (left) and TwinCAT 3.

The persistent data are saved by default under \TwinCAT\Boot in TwinCAT 2 and under \TwinCAT\3.1\Boot in TwinCAT 3.

The FBWF can be configured via the Beckhoff FBWF manager.

### UWF exception list

By default an exception list is automatically created when the UWF is switched on. The \Boot directory is already entered in this list. Check the configuration of the UWF if you have made changes to the exception list.

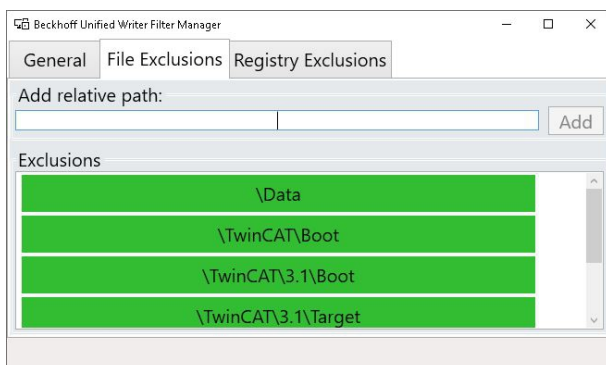

Fig. 38: UWF exception list under TwinCAT 3

By default, the persistent data are stored under \TwinCAT\3.1\Boot in TwinCAT 3.

The UWF can be configured via the Beckhoff Unified Write Filter Manager.

## 9.2 Checking the validity of the variables

For TwinCAT 2 the implicit structure `SystemInfoType.bootDataFlags` can be read in order to determine the validity of the persistent data (see: [SYSTEMINFOTYPE \[► 66\]](#)).

For TwinCAT 3 the implicit variables `PlcAppSystemInfo.BootDataLoaded` and `PlcAppSystemInfo.OldBootData` are available for determining the validity of the persistent data (see: [PlcAppSystemInfo \[► 68\]](#)).

### 9.2.1 SYSTEMINFOTYPE

```
TYPE SYSTEMINFOTYPE
STRUCT
runTimeNo :BYTE;
projectName :STRING(32);
numberOfTasks :BYTE;
onlineChangeCount :UINT;
bootDataFlags :BYTE;
systemStateFlags :WORD;
END_STRUCT
END_TYPE
```

**runTimeNo:** specifies the number of the runtime system (1..4).

**projectName:** project name as STRING.

**numberOfTasks:** number of tasks contained in the runtime system (max. 4).

**onlineChangeCount:** number of online changes since the last complete download.

**bootDataFlags:** State of the boot data (RETAIN and PERSISTENT) after loading. The upper four bits indicate the state of the persistent data, while the lower four bits indicate the state of the retain data.

Bit number	Description
0	RETAIN variables: LOADED (without error)
1	RETAIN variables: INVALID (the back-up copy was loaded, since no valid data was present)
2	RETAIN variables: REQUESTED (RETAIN variables should be loaded, a setting in TwinCAT System Control)
3	reserved
4	PERSISTENT variables: LOADED (without error)
5	PERSISTENT variables: INVALID (the back-up copy was loaded, since no valid data was present)
6	reserved
7	reserved

**systemStateFlags** : Reserved.

When shutting TwinCAT down the PERSISTENT and RETAIN data is written into two files on the hard disk. The path can be specified in TwinCAT System Control by means of the TwinCAT system properties (PLC tab). The standard setting is "<Drive>:\TwinCAT\Boot". The files all have a fixed name with fixed extensions:

File name	Description
TCPLC_P_x.wbp	Boot project (x = number of the run-time system)
TCPLC_S_x.wbp	Packed source code (x = number of the runtime system)
TCPLC_R_x.wbp	RETAIN variables (x = number of the runtime system)
TCPLC_T_x.wbp	PERSISTENT variables (x = number of the runtime system)
TCPLC_R_x.wb~	Backup copy of the RETAIN variables (x = number of the runtime system)
TCPLC_T_x.wb~	Backup copy of the PERSISTENT variables (x = number of the runtime system)

If the persistent or retain variables are not loaded, e.g. because they are invalid, the backup file is loaded by default. In that case bit 1 of the bootDataFlags (for the RETAIN variables) in the PLC and/or bit 5 (for the PERSISTENT variables) is set.

A registry setting can be used to determine whether the backup file is deleted or used. The backup file is used by default (setting 0). If the backup file is to be deleted, the value of "ClearInvalidRetainData" or "ClearInvalidPersistentData" must be set to 1 in the registry under:

```
[HKEY_LOCAL_MACHINE\SOFTWARE\Beckhoff\TwinCAT\Plc]
"ClearInvalidRetainData"=dword:00000000
"ClearInvalidPersistentData"=dword:00000000
```

the value of "ClearInvalidRetainData" or of "ClearInvalidPersistentData" must be set to 1.

Whether the backup file is to be used can also be set in the TwinCAT System Manager in the tree structure on the left under **PLC > PLC Settings**:

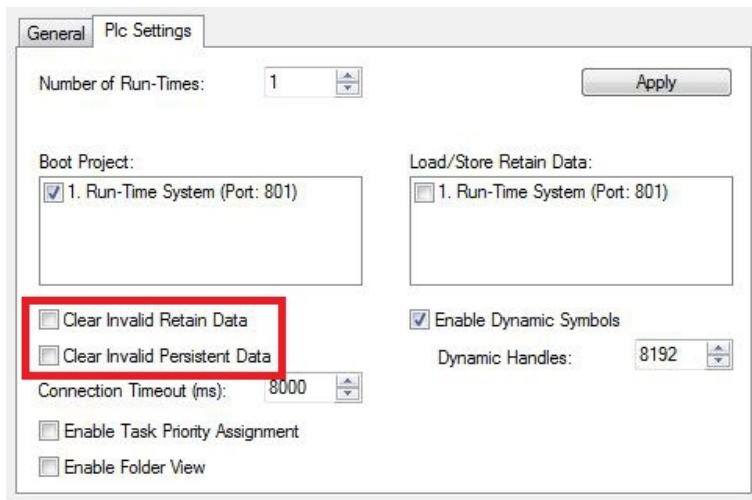

The backup files are deleted if the option **Clear Invalid Retain Data** or **Clear Invalid Persistent Data** is set in the System Manager. Corresponds to registry entry 1.

Development environment	Target platform	PLC libraries to be linked
TwinCAT v2.7.0	PC or CX (x86)	PLCSystem.Lib
TwinCAT v2.8.0	PC or CX (x86)	TcSystem.Lib
TwinCAT v2.10.0 Build >= 1301	CX (ARM)	TcSystem.Lib

## 9.2.2 PlcAppSystemInfo

Each PLC provides a global instance of this type named '\_AppInfo'. The corresponding namespace is 'TwinCAT\_SystemInfoVarList'. For example this has to be added inside a library.

```

TYPE PlcAppSystemInfo
STRUCT
  ObjId          : OTCID;
  TaskCnt        : UDINT;
  OnlineChangeCnt : UDINT;
  Flags          : DWORD;
  AdsPort        : UINT;
  BootDataLoaded : BOOL;
  OldBootData    : BOOL;
  AppTimestamp   : DT;
  KeepOutputsOnBP : BOOL;

  TComSrvPtr     : ITComObjectServer;

  AppName        : STRING(63);

  ProjectName    : STRING(63);
END_STRUCT
END_TYPE

```

<b>ObjId</b>	object ID of the PLC project instance
<b>TaskCnt</b>	The number of tasks in the actual runtime system.
<b>OnlineChangeCnt</b>	The number of online changes made since the last complete download.
<b>Flags</b>	Reserved for future use
<b>AdsPort</b>	ADS port of PLC application
<b>BootDataLoaded</b>	PERSISTENT variables: LOADED (without error)
<b>OldBootData</b>	PERSISTENT variables: INVALID (the back-up copy was loaded, since no valid data was present)
<b>AppTimestamp</b>	Date and time of application start
<b>KeepOutputsOnBP</b>	The flag can be set to avoid that the outputs are zero-filled if a breakpoint is reached. The task keeps running. Only the execution of PLC code is interrupted.
<b>TComSrvPtr</b>	Pointer to TcCOM Object Server
<b>AppName</b>	TwinCAT generated name containing the port number.
<b>ProjectName</b>	The name of the PLC project.

### Differences to TwinCAT 2

If the variable runTimeNo was used under TwinCAT 2, the program code has to be changed.

#### Example

- **Usage in TwwincAT 2:** nPlcAdsPort := 801 + (SystemInfo.runTimeNo - 1) \* 10;
- **Usage in TwinCAT 3:** nPlcAdsPort := \_AppInfo.AdsPort;

# 10 Error handling and diagnostics

## 10.1 Basic CPU module

### 10.1.1 LEDs on the basic CPU module

Display	LED	Meaning
	PWR	Power supply. The Power LED comes on when the device is connected to a live power supply unit (green).
	TC	TwinCAT status LED: TwinCAT is in Run mode (green). TwinCAT is in Stop mode (red). TwinCAT is in Config mode (blue).
	HDD	Read/Write CFast card (red). Indicates access to the CFast card.
	FB1	Status LED for optional interface (the function is described in the documentation for the respective optional interface).
	FB2	Status LED for optional interface (the function is described in the documentation for the respective optional interface).

### 10.1.2 Power supply terminal LEDs in K-bus mode

The power supply unit checks the connected Bus Terminals for errors. The red LED "K-bus ERR" is off if no error is present. The red LED "K-bus ERR" flashes if Bus Terminal errors are present.

Display	LED	Meaning
	Us 24 V	Power supply for basic CPU module. The LED lights green if the power supply is correct.
	Up 24V	Power supply for terminal bus. The LED lights green if the power supply is correct.
	K-BUS RUN	Diagnostic K-bus. The green LED lights up in order to indicate fault-free operation. "Error-free" means that the communication with the fieldbus system is also running.
	K-BUS ERR	Diagnostic K-bus. The red LED flashes to indicate an error. The red LED blinks with two different frequencies.

The frequency and number of the flashes can be used to determine the error code and the error argument. An error is indicated by the "K-bus ERR" LED in a particular order.

Table 32: K-bus ERR LED, fault indication sequence through the LED.

Order	Meaning
Fast blinking	Starting the sequence
<b>First slow sequence</b>	<b>Error code</b>
No display	Pause, the LED is off
<b>Second slow sequence</b>	<b>Error code argument</b>

Count how often the red LED K-bus ERR flashes, in order to determine the error code and the error argument. In the error argument the number of pulses shows the position of the last Bus Terminal before the error. Passive Bus Terminals, such as a power feed terminal, are not included in the count.

Table 33: K-BUS ERR LED, fault description and troubleshooting.

Error code	Error code argument	Description	Remedy
Persistent, continuous flashing		EMC problems.	<ul style="list-style-type: none"> <li>• Check power supply for undervoltage or overvoltage peaks.</li> <li>• Implement EMC measures.</li> <li>• If a K-bus error is present, it can be localized by a restart of the power supply (by switching it off and then on again)</li> </ul>
3 pulses	0	K-bus command error.	<ul style="list-style-type: none"> <li>• No Bus Terminal inserted.</li> <li>• One of the Bus Terminals is defective; halve the number of Bus Terminals attached and check whether the error is still present with the remaining Bus Terminals. Repeat this procedure until the faulty Bus Terminal has been found.</li> </ul>
4 pulses	0	K-bus data error, break behind the power supply unit.	Check whether the Bus End Terminal 9010 is connected.
	n	Break behind Bus Terminal n	Check whether Bus Terminal n+1 after the power supply unit is connected correctly; replace if necessary.
5 pulses	n	K-bus error in register communication with Bus Terminal n.	Replace Bus Terminal at location n.
6 pulses	0	Error at initialization.	Replace Embedded PC.
	1	Internal data error.	Hardware reset of the Embedded PC (switch off and back on again).
	8	Internal data error.	Hardware reset of the Embedded PC (switch off and back on again).
7 pulses	0	Process data lengths of the set and actual configurations do not correspond.	Check the configuration and the Bus Terminals for consistency.

For some error the LED "K-BUS ERR" does not go out, even if the error was rectified. Switch the power supply for the power supply unit off and back on again to switch off the LED after the error has been rectified.

### State variable

In TwinCAT there is a State variable under the Bus Coupler for K-bus diagnostics.



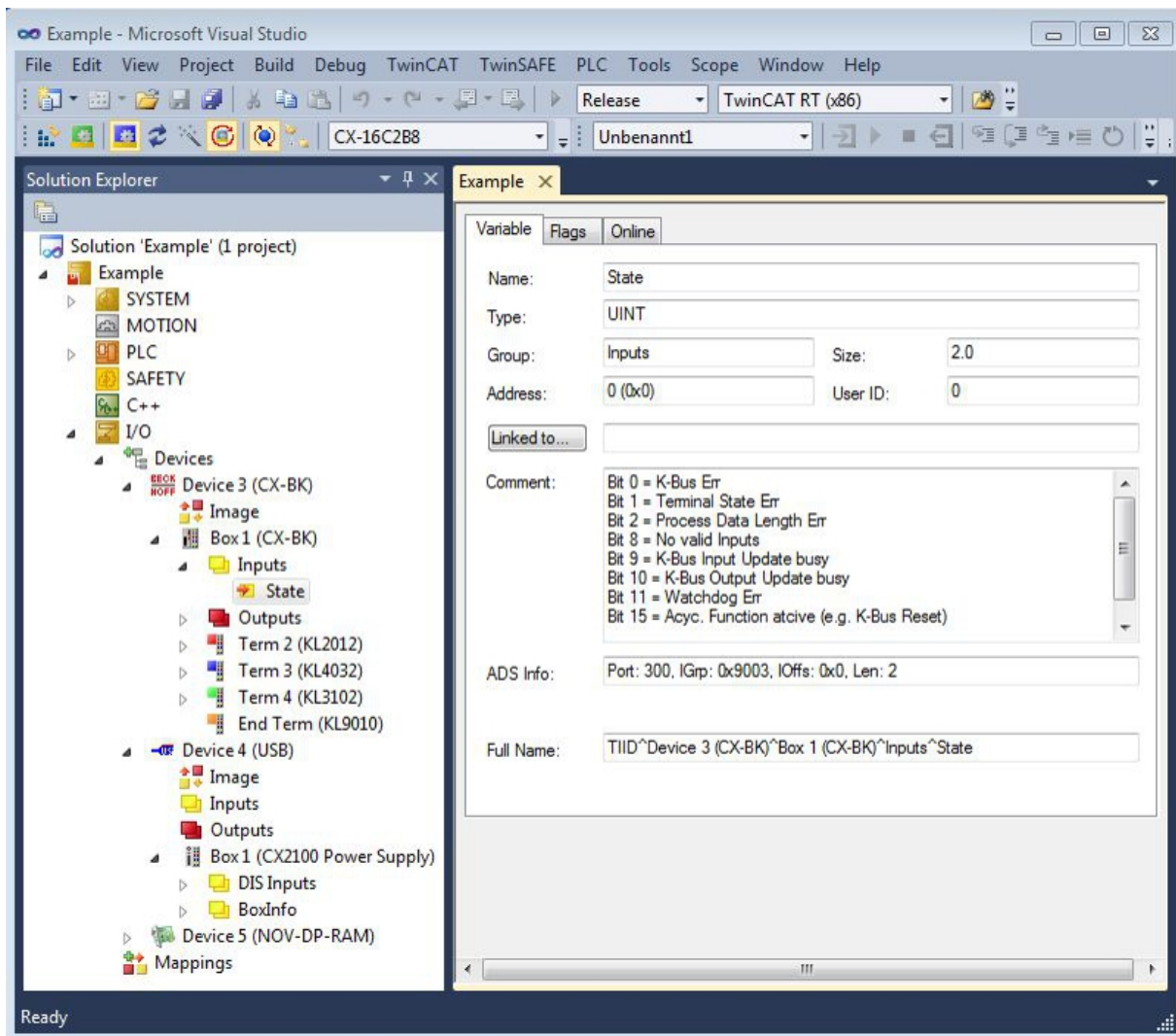

Fig. 39: Status variable for error handling and diagnostics under TwinCAT.

If the value is "0", the K-bus operates synchronous and without error. If the value is  $\neq$  "0" there may be a fault, or it may only be an indication that the K-bus cycle is longer than the task. In which case it would no longer be synchronous with the task. The task time should be faster than 100 ms. We recommend a task time of less than 50 ms. The K-bus update time typically lies between one and five ms.

Table 34: Description of the State variable values.

Bit	Description
Bit 0	K-bus error.
Bit 1	Terminal configuration has changed since the start.
Bit 2	Process image lengths do not match.
Bit 8	(still) no valid inputs.
Bit 9	K-bus input update not yet complete.
Bit 10	K-bus output update not yet complete.
Bit 11	Watchdog.
Bit 15	Acyclic K-bus function active (e.g. K-bus reset).

If there is a K-bus error, this can be reset via the IOF\_DeviceReset function block (in the TcIoFunctions.lib).

### 10.1.3 Power supply terminal LEDs in K-bus mode

The power supply unit checks the connected EtherCAT Terminals. The "L/A" LED is lit in E-bus mode. The "L/A" LED flashes during data transfer.

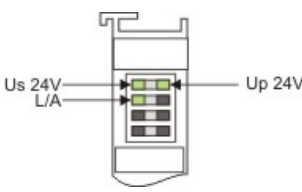
Display	LED	Meaning	
	Us 24 V	Power supply for basic CPU module. The LED lights green if the power supply is correct.	
	Up 24 V	Power supply for terminal bus. The LED lights green if the power supply is correct.	
	L / A	off	E-bus not connected.
		on	E-bus connected / no data traffic.
	flashes	E-bus connected / data traffic on the E-bus.	

## 10.2 Faults

Table 35: Possible faults and their correction.

Fault	Cause	Measures
No function after the Embedded PC has been switched on.	<ul style="list-style-type: none"> <li>No power supply for the Embedded PC</li> <li>Other causes.</li> </ul>	<ol style="list-style-type: none"> <li>Check the fuse.</li> <li>Check the supply voltage and the pin assignment.</li> <li>Call Beckhoff support.</li> </ol>
Embedded PC does not boot fully.	Hard disk damaged (e.g. due to switching off while software is running), incorrect setup, other causes.	<ol style="list-style-type: none"> <li>Check setup.</li> <li>Call Beckhoff support.</li> </ol>
Computer boots, software starts, but control system does not operate correctly.	Cause of the fault is either in the software or in parts of the plant outside the Embedded PC.	Call the manufacturer of the machine or the software.
Error during CFast card access.	Faulty CFast card, faulty card slot.	<ol style="list-style-type: none"> <li>Use another CFast card to test the card slot.</li> <li>Call Beckhoff support.</li> </ol>
Embedded PC only works partially or temporarily.	Defective components in the Embedded PC.	Call Beckhoff support.
The time and date are no longer saved.	The service life of the battery is exceeded	<a href="#">Replace the battery [► 74]</a> .
The fan does not turn (for CX2040 or CX20x0 Embedded PC with fan option).	Fan faulty.	<a href="#">Replace the fan cartridge [► 75]</a> .
CX20x0 with Windows Embedded Compact 7 does not find new hardware (e.g. extension modules).	The Embedded PC only searches for new hardware at the PCI bus on first startup.	Delete the folder "Documents and Settings" on the CFast card. See: <a href="#">Scan for new hardware [► 40]</a>

Please make a note of the following information **before** contacting Beckhoff service or support:

1. Precise device ID: CXxxxx-xxxx.
2. Serial number.
3. Hardware version.
4. Any interfaces (N030, N031, B110, ...).
5. TwinCAT version used.
6. Any components / software used

The quickest response will come from support / service in your country. Therefore please contact your regional contact. Check on our website at [www.beckhoff.de](http://www.beckhoff.de) or ask your distribution partner.

# 11 Care and maintenance

## 11.1 Replace the battery



### Attention

#### Risk of explosion

An incorrectly inserted battery may explode and damage the Embedded PC.

Only use original batteries and ensure that the positive and negative poles are inserted correctly.

The battery must be replaced every 5 years. Spare batteries can be ordered from Beckhoff Service. A battery of type CR2032 from Sanyo or Panasonic is used for the Embedded PC.

Table 36: Technical data of the battery.

Battery type	Electrical properties (at 20 °C)		Standard charge	Dimensions		
	nominal voltage	nominal capacity	continuous load	Diameter	Height	Weight
CR2032	3.0 V	225 mAh	0.20 mA	20.0 mm	3.20 mm	3.1 g

The battery compartment is below the front flap. The battery stores the time and date. The time and date are reset if the battery is removed.

Be aware of this behavior for your hardware and software configuration and reset the time and date in the BIOS after a battery change. All other BIOS settings remain unchanged and are retained.

Requirements:

- The Embedded PC is switched off.

Replace the battery as follows:

1. Lever the front flap open with a screwdriver and remove it.
2. Carefully pull the battery from the bracket.

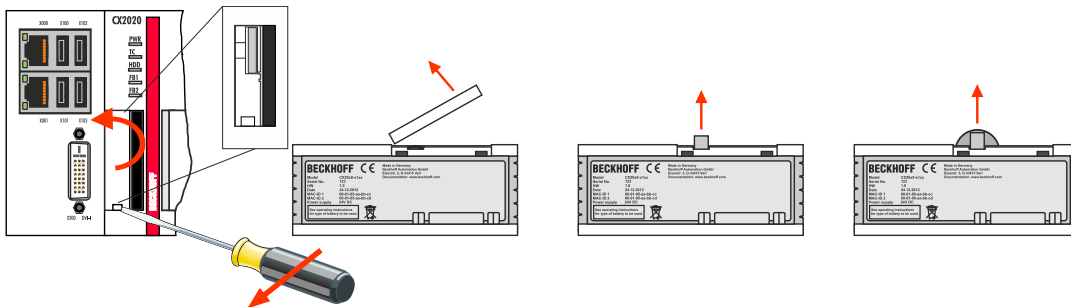

3. Push the new battery into the battery compartment. The positive pole points to the left towards the DVI-I interface.

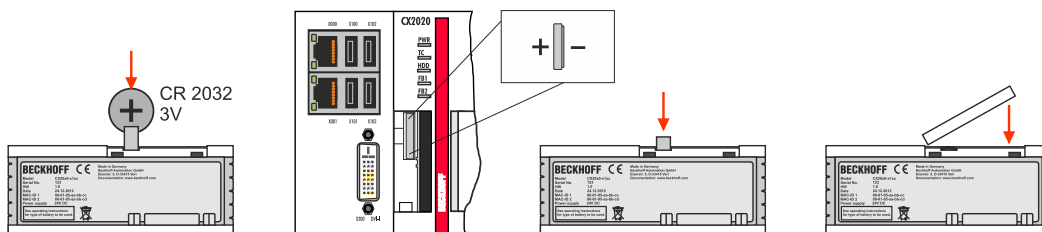

⇒ The battery change is complete. Close the front flap and reset the date and time in the BIOS.

## 11.2 Replace the fan cartridge



**Note**

### Service life

The fan cartridge must be replaced every 5 years. Spare fan cartridges can be ordered from Beckhoff Service.

Replace the fan cartridge of the CX20x0 if:

- the fan cartridge has been used for 5 years
- or the fan speed is less than 1000 rpm.

In a CX20x0 Embedded PC the fan speed is controlled depending on the temperature.

*Table 37: In the CX20x0 the fan control and speed depend on the temperature.*

Temperature	Fan control	Fan speed
at 35 °C	0 %	1500 rpm
35 °C ... 61.25 °C	0% ... 100%, linear control	1500 rpm...5900 rpm, linear control
above 61.25 °C	100 %	5900 rpm

Use the IPC diagnostics and monitor the fan speed to determine a fan fault.

Access to the fan status is described in the documentation for the IPC diagnostics:

[https://download.beckhoff.com/download/document/ipc/industrial-pc/ipc\\_diagnose\\_de.pdf](https://download.beckhoff.com/download/document/ipc/industrial-pc/ipc_diagnose_de.pdf)

### Replace the fan cartridge as follows:

1. Open the front flap.
2. Pull the old fan cartridge from the housing.

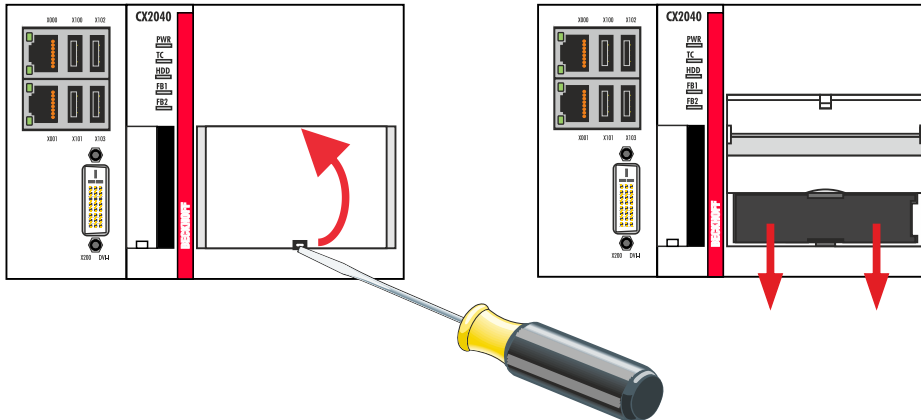

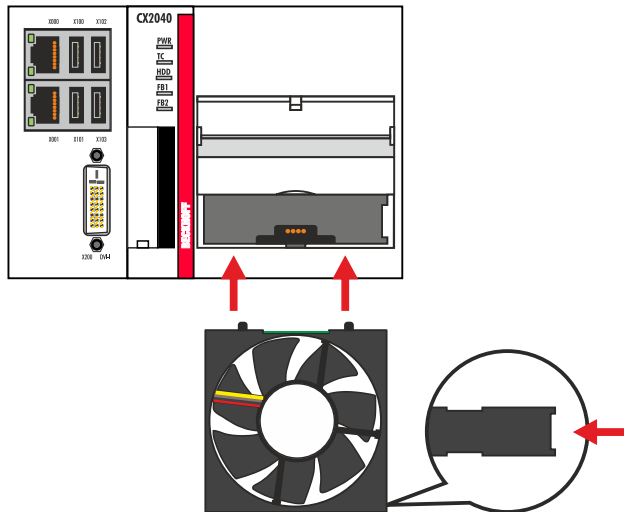

3. Push the new fan cartridge into the housing, with the contacts first. The guide rails at the fan match the guide rails in the housing.



⇒ Close the front flap. You have successfully changed the fan cartridge if the fan starts up again.

# 12 Decommissioning

## 12.1 Removing cables

 <b>Note</b>	<p><b>Electrical voltage</b></p> <p>Having the power supply switched on during the disassembly may damage the device. Switch off the power supply during the disassembly.</p>
 <b>Note</b>	<p><b>Cabling</b></p> <p>Make a note of the wiring configuration, if you wish to restore it with another device.</p>

Before dismantling the Embedded PC, shut down the Embedded PC and switch off the power supply. Only then can you remove all the cables. Also remove all cables from the first terminal after the power supply terminal.

Requirements:

- Exit the software and shut down the Embedded PC.
- Switch off the power supply.

**Remove the cables as follows:**

1. Remove the wiring from the basic CPU module, any system interfaces that may be connected and the extension modules.
2. Remove the wiring from the first terminal next to the power supply terminal.
3. Pull the orange strap to remove the first terminal after the power supply terminal by pulling it forward.

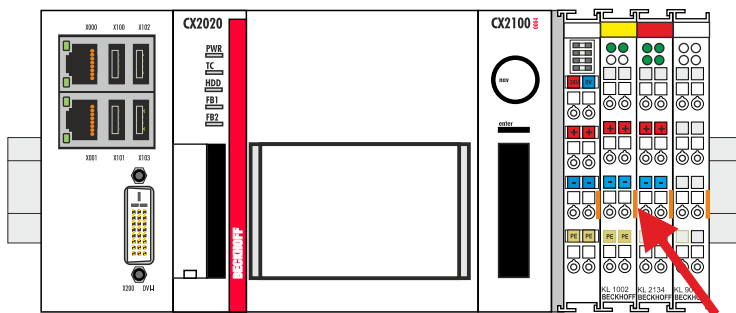

⇒ In the next step the Embedded PC can be removed from the DIN rail and dismantled.

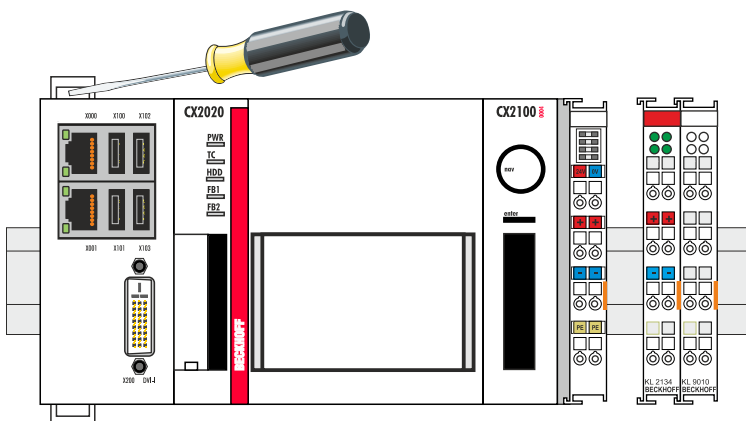

## 12.2 Dismantling the Embedded PC

The CX2000 Embedded PC series is a modular system and enables individual modules to be replaced or removed quite easily. This section describes how to remove devices from the CX2000 Embedded PC series.

Requirements:

- All cables were removed from the Embedded PC.

**Dismantle the Embedded PC as follows:**

1. Release the DIN rail mounting by pushing the latches outwards with a screwdriver.

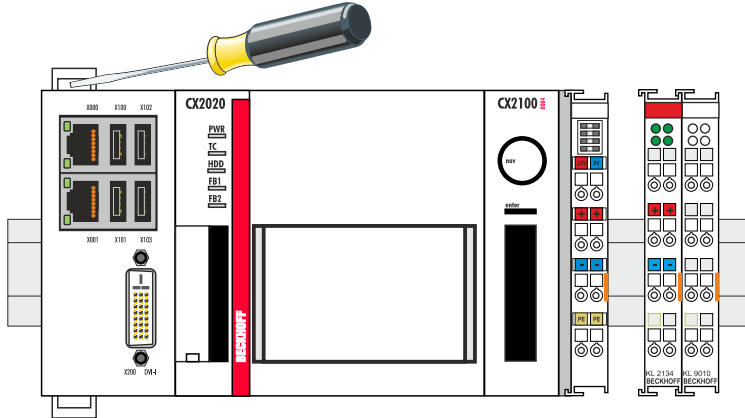

2. Pull the orange strap on the power supply unit and gently remove the device from the DIN rail.

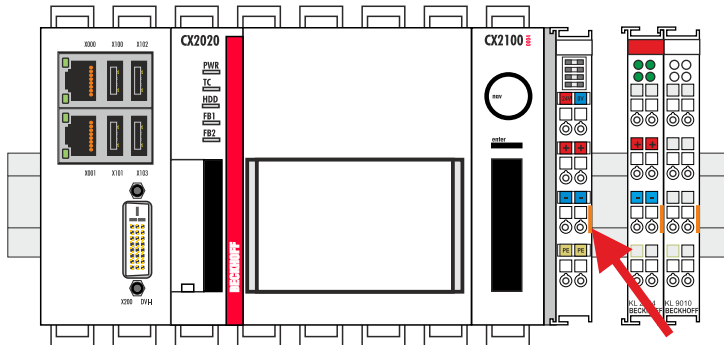

3. Lift the bar clips with the aid of a screwdriver and remove the bar clips.

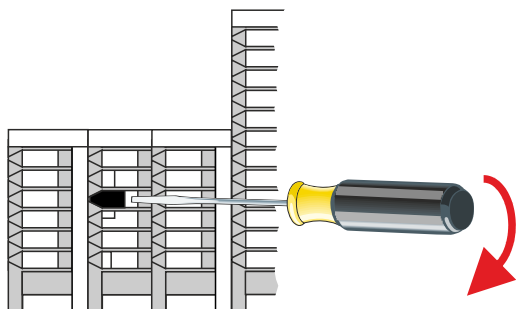



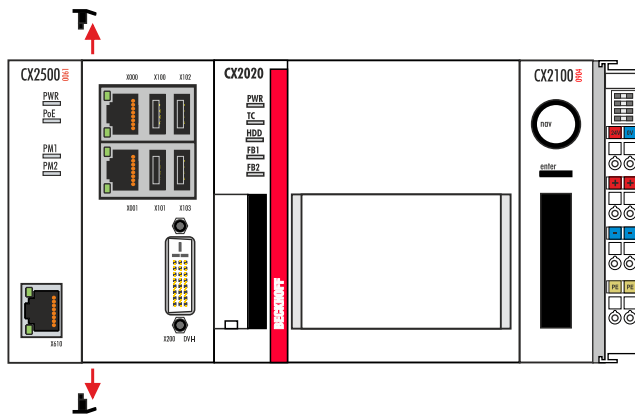

⇒ Once the bar clips have been removed successfully, the modules can be separated from each other.

**Disposal**

The device must be fully dismantled in order to dispose of it. Electronic components must be disposed of according to national electronic waste regulations.

# 13 Technical data

Table 38: Technical data, dimensions and weights.

	CX2020	CX2030	CX2040
Dimensions (W x H x D)	144 mm x 99 mm x 91 mm		
Weight	approx. 1160 g	approx. 1165 g	approx. 1230 g

Table 39: Technical data, general data.

Technical data	CX2020	CX2030	CX2040
Processor	Intel® Celeron® 827E 1,4 GHz, single-core	Intel® Core™ i7 2610UE 1,5 GHz, dual-core	Intel® Core™ i7 2715QE 2,1 GHz, quad-core
Main memory	2 GB DDR3-RAM	2 GB DDR3-RAM	4 GB DDR3-RAM
Flash memory	4 GB or 8 GB, CFast card with extended temperature range (optionally extendable)		
NOVRAM integrated	128 kB		
Power supply	24 V DC (-15 %/+20 %)		
max. power loss	15 W (including the system interfaces)	20 W (including the system interfaces)	42 W (including the system interfaces)
Dielectric strength	500 V (supply / internal electronics)		
Operating system	Microsoft Windows Embedded Compact 7 Microsoft Windows Embedded Standard 7 P Microsoft Windows 10 IoT Enterprise LTSC		
Control software	TwinCAT-2-PLC-Runtime, -NC-PTP-Runtime, -NC-I-Runtime TwinCAT 3		
Diagnostics LED	1 x power, 1 x TC status, 1 x flash access, 2 x bus status		
Clock	Internal battery-backed clock for time and date (battery replaceable)		
Approvals	CE, UL		

Table 40: Technical data, I/O terminals.

Technical data	Description
I/O connection	via power supply unit (E-bus or K-bus, automatic detection)
Power supply for I/O terminals	max. 2A
Current load of the power contacts	max. 10 A
Process data on the K-bus	max. 2048 bytes input and 2048 bytes output
max. number of terminals (K-bus)	64 (255 with K-bus extension)
max. number of terminals (E-bus)	up to 65534 terminals.

Table 41: Technical data, environmental conditions.

Technical data	Description
Ambient temperature during operation	-25 °C to +60 °C
Ambient temperature during storage	-40 °C to +85 °C See notes under: <a href="#">Transport and storage [► 10]</a>
Relative humidity	95% without condensation
Vibration resistance	10 frequency sweeps in 3 axes 6 Hz < f < 58.1 Hz displacement 0.15 mm, constant amplitude 58.1 Hz < f < 500 Hz acceleration 5 g, constant amplitude According to EN 60068-2-6
Shock resistance	1000 shocks in each direction, in 3 axes 15 g, 11 ms according to EN 60068-2-27
EMC immunity	according to EN 61000-6-2
Electromagnetic emission	according to EN 61000-6-4
Protection class	IP 20

Table 42: Technical data, graphic specifications.

Technical data	CX2020	CX2030	CX2040
Processor graphics	Intel® HD Graphics	Intel® HD Graphics 3000	Intel® HD Graphics 3000
Graphic memory	128 MB (Shared Memory)		
Base clock frequency	350 MHz	350 MHz	650 MHz
Max. dynamic graphic frequency	800 MHz	850 MHz	1.2 GHz
Shader Model	4.1		
DirectX	10.1		
OpenGL	3.1		

Table 43: Technical data, interfaces.

Technical data	Description
LAN	2 x RJ 45, 10/100/1000 MBit/s
USB	4 x USB 2.0 each rated at 500 mA, type A
DVI-I	Resolution on the monitor in pixels: 640 x 480 to 1920 x 1200

Table 44: Technical data, optional interfaces.

Technical data	Description
DVI-D	Resolution on the monitor in pixels: 640 x 480 to 1920 x 1200
DisplayPort	Resolution on the monitor in pixels: max. 2560x1600
RS232	D-Sub plug, 9-pin Electrical isolation 500 V
RS422/RS485	D-Sub plug, 9-pin Electrical isolation 500 V
EtherCAT slave	2 x RJ 45, EtherCAT IN and OUT 100 MBaud
PROFIBUS	D-Sub plug, 9-pin 9,6 kbaud to 12 Mbaud
CANopen	D-Sub plug, 9-pin 10 kbaud to 1,000 kbaud
PROFINET RT	2 x RJ-45 switches

## 14 Appendix

### 14.1 Accessories

Table 45: CFast cards

Order number	Description
CX2900-0028	4 GB CFast card, SLC flash, extended temperature range
CX2900-0030	8 GB CFast card, SLC flash, extended temperature range
CX2900-0032	16 GB CFast card, SLC flash, extended temperature range
CX2900-0034	32 GB CFast card, SLC flash, extended temperature range
CX2900-0036	64 GB CFast card, SLC flash, extended temperature range
CX2900-0038	30 GB CFast card, 3D flash, extended temperature range
CX2900-0040	60 GB CFast card, 3D flash, extended temperature range

larger capacities on request

Table 46: HDD/SSD

Order number	Description
CX2900-0401	Hard disk, SATA, 2½-inch, 1 TB
CX2900-0502	Solid-state disk SSD, SATA, 3D flash, 2½-inch, 120 GB
CX2900-0503	Solid-state disk SSD, SATA, 3D flash, 2½-inch, 240 GB
CX2900-0504	Solid-state disk SSD, SATA, 3D flash, 2½-inch, 480 GB

larger capacities on request

Table 47: Passive DVI-to-VGA adaptor.

Order number	Description
CX1900-0101	Passive DVI-to-VGA adaptor for the connection of standard VGA monitors to the CX system – feeds out the VGA signals of the DVI-I interface of the CX module – DVI-A plug, 29-pin (bottom), socket, 15-pin (top) – Weight: approx. 40 g – Dimensions (W x H x D): 40 x 42 x 15 mm

Table 48: Spare battery for CX systems.

Order number	Description
CX1900-0102	Battery for CX systems Original manufacturer's designation: Panasonic type CR2032 3V/225 mAh

Table 49: Other spare parts.

Order number	Description
CX2900-0101	Housing locking clips (black) for the CX20x0 series. 10 locking pin sets (each set consisting of two pieces).
CX2900-0102	Cover for left-side module bus connector, 5 pieces
CX2900-0103	Spare fan cartridge for CX2040, CX2042, CX2062, CX2072 and CX2020, CX2030 with fan option – cartridge consisting of chassis and 60 mm fan – simple exchange in the field due to wireless installation – Weight: approx. 30 g – dimensions (W x H x D) 67 x 62 x 16 mm

## 14.2 Certifications

All products of the Embedded PC family are CE, UL and EAC certified. Since the product family is continuously developed further, we are unable to provide a full listing here. The current list of certified products can be found at [www.beckhoff.com](http://www.beckhoff.com).

### **FCC Approvals for the United States of America**

#### **FCC: Federal Communications Commission Radio Frequency Interference Statement**

This equipment has been tested and found to comply with the limits for a Class A digital device, pursuant to Part 15 of the FCC Rules. These limits are designed to provide reasonable protection against harmful interference when the equipment is operated in a commercial environment. This equipment generates, uses, and can radiate radio frequency energy and, if not installed and used in accordance with the instruction manual, may cause harmful interference to radio communications. Operation of this equipment in a residential area is likely to cause harmful interference in which case the user will be required to correct the interference at his own expense.

### **FCC Approval for Canada**

#### **FCC: Canadian Notice**

This equipment does not exceed the Class A limits for radiated emissions as described in the Radio Interference Regulations of the Canadian Department of Communications.

## 14.3 Support and Service

Beckhoff and their partners around the world offer comprehensive support and service, making available fast and competent assistance with all questions related to Beckhoff products and system solutions.

### Beckhoff's branch offices and representatives

Please contact your Beckhoff branch office or representative for local support and service on Beckhoff products!

The addresses of Beckhoff's branch offices and representatives round the world can be found on her internet pages:

<http://www.beckhoff.com>

You will also find further documentation for Beckhoff components there.

### Beckhoff Headquarters

Beckhoff Automation GmbH & Co. KG

Huelshorstweg 20  
33415 Verl  
Germany

Phone:	+49(0)5246/963-0
Fax:	+49(0)5246/963-198
e-mail:	info@beckhoff.com

### Beckhoff Support

Support offers you comprehensive technical assistance, helping you not only with the application of individual Beckhoff products, but also with other, wide-ranging services:

- support
- design, programming and commissioning of complex automation systems
- and extensive training program for Beckhoff system components

Hotline:	+49(0)5246/963-157
Fax:	+49(0)5246/963-9157
e-mail:	support@beckhoff.com

### Beckhoff Service

The Beckhoff Service Center supports you in all matters of after-sales service:

- on-site service
- repair service
- spare parts service
- hotline service

Hotline:	+49(0)5246/963-460
Fax:	+49(0)5246/963-479
e-mail:	service@beckhoff.com

# List of tables

Table 1	Dimensions and weight of the individual modules .....	10
Table 2	Available optional interfaces for the CX20x0 .....	12
Table 3	Legend for the configuration of the basic CPU module .....	13
Table 4	Legend for the name plate .....	14
Table 5	CX20x0, ordering information for software .....	16
Table 6	USB interfaces (X100, X101, X102, X103), pin assignment .....	19
Table 7	Ethernet interface X000 and X001, pin assignment .....	20
Table 8	DVI-I interface X200, pin assignment .....	21
Table 9	DVI-I cross, pin assignment .....	21
Table 10	DVI-I interface X200, resolution at the monitor .....	21
Table 11	DVI-D interface X300, pin assignment .....	22
Table 12	DVI-D interface X300, resolution at the monitor .....	22
Table 13	DisplayPort, pin assignment .....	23
Table 14	DisplayPort X300, resolution at the monitor .....	23
Table 15	RS232 interface X300, pin assignment .....	24
Table 16	RS422/485 interface, pin assignment .....	25
Table 17	Default setting, RS485 without echo with end point (terminated) .....	25
Table 18	EtherCAT slave interface X300, pin assignment .....	26
Table 19	PROFIBUS interface X310, pin assignment .....	27
Table 20	Wire colors of the PROFIBUS line .....	27
Table 21	CANopen interface X510, pin assignment .....	28
Table 22	PROFINET RT interface, pin assignment .....	29
Table 23	Power supply units for basic CPU modules with passive cooling .....	30
Table 24	Power supply units for basic CPU modules with active cooling .....	30
Table 25	Legend for configuration of the power supply terminal .....	30
Table 26	Embedded PC CX20x0, installation position depending on the cooling option .....	32
Table 27	Legend for the connection example .....	37
Table 28	Required wire cross-sections and strip lengths .....	38
Table 29	Access data for the Beckhoff Device Manager on delivery .....	47
Table 30	Legend for the tree view .....	49
Table 31	Cable redundancy, hardware for sample configuration .....	53
Table 32	K-bus ERR LED, fault indication sequence through the LED .....	69
Table 33	K-BUS ERR LED, fault description and troubleshooting .....	70
Table 34	Description of the State variable values .....	71
Table 35	Possible faults and their correction .....	73
Table 36	Technical data of the battery .....	74
Table 37	In the CX20x0 the fan control and speed depend on the temperature .....	75
Table 38	Technical data, dimensions and weights .....	80
Table 39	Technical data, general data .....	80
Table 40	Technical data, I/O terminals .....	80
Table 41	Technical data, environmental conditions .....	81
Table 42	Technical data, graphic specifications .....	81
Table 43	Technical data, interfaces .....	81
Table 44	Technical data, optional interfaces .....	81

---

Table 45 CFast cards .....	82
Table 46 HDD/SSD.....	82
Table 47 Passive DVI-to-VGA adaptor.....	82
Table 48 Spare battery for CX systems.....	82
Table 49 Other spare parts.....	82



# List of figures

Fig. 1	Overview of the CX2000 product family with basic CPU module, power supply unit and modules. ....	11
Fig. 2	Example: Embedded PCs CX2040 with active cooling. ....	13
Fig. 3	CX20x0 name plate. ....	14
Fig. 4	Nomenclature for the basic CPU module. ....	16
Fig. 5	CX20x0 architecture overview. ....	17
Fig. 6	USB interfaces (X100, X101, X102, X103).....	19
Fig. 7	USB interface, pin numbering.....	19
Fig. 8	Ethernet interface X000, X001.....	20
Fig. 9	Ethernet interface, pin numbering.....	20
Fig. 10	DVI-I interface X200. ....	21
Fig. 11	DVI-D interface X300.....	22
Fig. 12	DisplayPort X300. ....	23
Fig. 13	RS232 interface X300 with pin numbering. ....	24
Fig. 14	RS485 interface X300 with pin numbering. ....	25
Fig. 15	EtherCAT slave interface X300. ....	26
Fig. 16	EtherCAT slave LAN interface, pin numbering. ....	26
Fig. 17	PROFIBUS interface X310 with pin numbering. ....	27
Fig. 18	CANopen interface X510 with pin numbering.....	28
Fig. 19	PROFINET RT interface X300.....	29
Fig. 20	PROFINET RT LAN interface, pin numbering. ....	29
Fig. 21	Embedded PC CX2020 with power supply unit CX2100-0004, configuration of the power supply terminal. ....	30
Fig. 22	Embedded PC CX20x0, horizontal installation position.....	32
Fig. 23	Embedded PC CX20x0, unacceptable installation positions without fan.....	33
Fig. 24	Embedded PC CX20x0, permitted installation positions with fan. ....	33
Fig. 25	Identifying a passive EtherCAT Terminal in TwinCAT.....	36
Fig. 26	Passive EtherCAT Terminals, permissible installation. ....	36
Fig. 27	Passive EtherCAT Terminals, invalid installation. ....	36
Fig. 28	Windows 7, Identification of the Ethernet interfaces (X000, X001) in the Network and Sharing Center. ....	41
Fig. 29	Windows 7, identification of the Ethernet interfaces (X000, X001) in the device manager. ....	41
Fig. 30	Windows 10, Identification of the Ethernet interfaces (X000, X001) in the Network and Sharing Center. ....	46
Fig. 31	Windows 10, identification of the Ethernet interfaces (X000, X001) in the device manager. ....	46
Fig. 32	CX20x0 Embedded PC in the tree view of TwinCAT 3, with attached EtherCAT Terminals (left) or Bus Terminals (right). ....	49
Fig. 33	Smallest possible configuration for EtherCAT cable redundancy.....	53
Fig. 34	Controller behavior with and without NOVRAM.....	57
Fig. 35	Retain Handler write speed, up to 63 kB in 512 byte steps.....	62
Fig. 36	Retain Handler write speed, up to 8 kB in 64 byte steps. ....	62
Fig. 37	FBWF exception list, under TwinCAT 2 (left) and TwinCAT 3.....	65
Fig. 38	UWF exception list under TwinCAT 3.....	65
Fig. 39	Status variable for error handling and diagnostics under TwinCAT.....	71