



**Installation and Operating instructions for**  
**C6925-0020/-0030**  
**Fanless Control Cabinet Industrial PC**

**Version: 1.0**  
**Date: 2016-05-27**

**BECKHOFF**



# Table of contents

<b>1</b>	<b>Foreword</b>	<b>3</b>
1.1	Notes on the Documentation	3
1.1.1	Liability Conditions	3
1.1.2	Trademarks	3
1.1.3	Patent Pending	3
1.1.4	Copyright	3
1.1.5	State at Delivery	3
1.1.6	Delivery conditions	3
1.2	Description of safety symbols	4
1.3	Basic safety measures	5
1.4	Operator's obligation to exercise diligence	6
1.4.1	National regulations	6
1.4.2	Procedure in the event of a fault	6
1.4.3	Operator requirements	6
<b>2</b>	<b>Product Description</b>	<b>7</b>
2.1	Product overview	7
2.2	Appropriate Use	8
2.3	Access to the CFast-Card and the Battery	8
2.4	Status-LEDs	9
2.5	Interfaces	10
2.5.1	Power Supply (X101)	10
2.5.2	Network connection (X102, X103)	10
2.5.3	USB-Interfaces (X104 – X107)	10
2.5.4	DVI (Digital Visual Interface) (X108)	10
2.5.5	PCIe Module Slots (X109, X110)	10
2.5.6	Earthing connection	10
<b>3</b>	<b>Installation</b>	<b>11</b>
3.1	Transport and Unpacking	11
3.1.1	Transport	11
3.1.2	Unpacking	11
3.2	Installation of the PC in the control cabinet	12
3.2.1	Preparation of the control cabinet	12
3.2.2	Earthing measures	12
3.3	Power supply of the Industrial PC	13
3.3.1	Beckhoff power supply technology	13
3.3.2	Fitting the cable	15

3.3.3	Connecting Power Supply	16
3.4	Connecting the Industrial PC	18
3.4.1	Connecting cables	18
3.4.2	Check voltage rating and connect	18
<b>4</b>	<b>Operating Instructions</b>	<b>19</b>
4.1	Switching the Industrial PC on and off	19
4.1.1	Switch on	19
4.1.2	Shutting down and switching off	19
4.1.3	First switching on and driver installation	19
4.2	Servicing and maintenance	20
4.2.1	Cleaning of the Industrial PC	20
4.2.2	Maintenance	20
4.2.3	Replacing the Battery on the Motherboard	20
4.3	Emergency procedures	20
4.4	Shutting down	20
4.4.1	Disposal	20
<b>5</b>	<b>UPS Software Components (optional)</b>	<b>21</b>
5.1	Installation on the PC	21
5.2	Help files	21
<b>6</b>	<b>Troubleshooting</b>	<b>22</b>
<b>7</b>	<b>Assembly dimensions</b>	<b>23</b>
<b>8</b>	<b>Technical Data</b>	<b>24</b>
<b>9</b>	<b>Appendix</b>	<b>25</b>
9.1	Beckhoff Support and Service	25
9.1.1	Beckhoff branches and partner companies	25
9.1.2	Beckhoff company headquarters	25
9.2	Approvals for USA and Canada	26
9.3	FCC Approvals for the United States of America	26
9.4	FCC Approval for Canada	26

# 1 Foreword

## 1.1 Notes on the Documentation

This description is only intended for the use of trained specialists in control and automation engineering who are familiar with the applicable national standards. It is essential that the following notes and explanations are followed when installing and commissioning these components.

The responsible staff must ensure that the application or use of the products described satisfy all the requirements for safety, including all the relevant laws, regulations, guidelines and standards.

### 1.1.1 Liability Conditions

The documentation has been prepared with care. The products described are, however, constantly under development. For that reason the documentation is not in every case checked for consistency with performance data, standards or other characteristics. In the event that it contains technical or editorial errors, we retain the right to make alterations at any time and without warning. No claims for the modification of products that have already been supplied may be made on the basis of the data, diagrams and descriptions in this documentation.

All pictures shown in the documentation are exemplary. Illustrated configurations can differ from standard.

### 1.1.2 Trademarks

Beckhoff®, TwinCAT®, EtherCAT®, Safety over EtherCAT®, TwinSAFE® and XFC® are registered trademarks of and licensed by Beckhoff Automation GmbH.

Other designations used in this publication may be trademarks whose use by third parties for their own purposes could violate the rights of the owners.

### 1.1.3 Patent Pending

The EtherCAT Technology is covered, including but not limited to the following patent applications and patents: EP1590927, EP1789857, DE102004044764, DE102007017835 with corresponding applications or registrations in various other countries.

The TwinCAT Technology is covered, including but not limited to the following patent applications and patents: EP0851348, US6167425 with corresponding applications or registrations in various other countries.

### 1.1.4 Copyright

© Beckhoff Automation GmbH & Co. KG.

The reproduction, distribution and utilization of this document as well as the communication of its contents to others without express authorization are prohibited. Offenders will be held liable for the payment of damages. All rights reserved in the event of the grant of a patent, utility model or design.

### 1.1.5 State at Delivery





All the components are supplied in particular hardware and software configurations appropriate for the application. Modifications to hardware or software configurations other than those described in the documentation are not permitted, and nullify the liability of Beckhoff Automation GmbH & Co. KG.

### 1.1.6 Delivery conditions

In addition, the general delivery conditions of the company Beckhoff Automation GmbH & Co. KG apply.

## 1.2 Description of safety symbols

The following safety symbols are used in this operating manual. They are intended to alert the reader to the associated safety instructions.

 <b>DANGER</b>	<p><b>Acute risk of injury!</b></p> <p>If you <b>do not</b> adhere the safety advise adjoining this symbol, there is immediate danger to life and health of individuals!</p>
 <b>WARNING</b>	<p><b>Risk of injury!</b></p> <p>If you <b>do not</b> adhere the safety advise adjoining this symbol, there is danger to life and health of individuals!</p>
 <b>CAUTION</b>	<p><b>Hazard to individuals!</b></p> <p>If you <b>do not</b> adhere the safety advise adjoining this symbol, there is obvious hazard to individuals!</p>
 <b>Attention</b>	<p><b>Hazard to devices and environment</b></p> <p>If you <b>do not</b> adhere the notice adjoining this symbol, there is obvious hazard to materials and environment.</p>
 <b>Note</b>	<p><b>Note or pointer</b></p> <p>This symbol indicates information that contributes to better understanding.</p>

## 1.3 Basic safety measures

Before the Industrial PC is switched off, software that is running must be properly closed. Otherwise it is possible that data on the storage medium is lost. Please read the section [Switching the Industrial PC on and off](#).

 <b>Attention</b>	<b>Switch off all parts of the equipment, then uncouple the fieldbus</b>  Before opening the housing, and whenever the Industrial PC is not being used for control purposes (such as during functional checks after a repair), all parts of the equipment must first be switched off, after which the Industrial PC is to be disconnected from the equipment.
---	---

Pulling out the fieldbus connection plug uncouples the PC (optional).  
Items of equipment that have been switched off must be secured against being switched on again.

The Industrial PC's power supply unit must be supplied with 24 V<sub>DC</sub>.

 <b>Attention</b>	<b>Do not exchange any parts when under power</b>  When components are being fitted or removed, the supply voltage must be switched off.  Fitting work on the Industrial PC can result in damage: <ul style="list-style-type: none"><li>• if metal objects such as screws or tools fall onto operating circuit boards.</li><li>• if connecting cables internal to the PC are removed or inserted during operation.</li><li>• if plug-in cards are removed or inserted when the PC is switched on.</li></ul>
---	---

## 1.4 Operator's obligation to exercise diligence

The operator must ensure that

- the product is only used as intended (see chapter [Product Description](#))
- the product is in a sound condition and in working order during operation
- the product is operated, maintained and repaired only by suitably qualified and authorized personnel
- the personnel is instructed regularly about relevant occupational safety and environmental protection aspects, and is familiar with the operating manual and in particular the safety notes contained herein
- the operation manual is in good condition and complete, and always available for reference at the location of the product.



**Attention**

### **Only trained persons may open the Industrial PC housing**

The operator is responsible for ensuring that only trained electrical staff opens the housing of the Industrial PC.

### 1.4.1 National regulations

Depending on the type of machine and plant in which the Industrial PC is used, national regulations governing the controllers of such machines will apply, and must be observed by the operator. These regulations cover, amongst other things, the intervals between inspections of the controller. The operator must initiate such inspections in good time.

### 1.4.2 Procedure in the event of a fault

In the event of faults at the Industrial PC, the list in the section [Troubleshooting](#) can be used to determine the measures to be taken.

### 1.4.3 Operator requirements

Anyone who uses the Industrial PC must have read these operating instructions and must be familiar with all the functions of the software installed on the Industrial PC to which he has access.



## 2 Product Description

### 2.1 Product overview



#### C6925 | Fanless control cabinet Industrial PC

The Industrial PC C6925 is designed for control cabinet installation. The compact housing is equipped with an Intel® Celeron® M ULV processor or Intel® Atom™ processor with up to four cores on a 3½-inch motherboard. All PC connections are located at the front of the housing. The cooling is done by cooling fins inside the housing. The PC can operate at temperatures up to 55 °C.

The Industrial PCs offer the following benefits:

- Industrial PC for space-saving control cabinet installation
- mounting sheet at the rear wall
- all connectors on the front
- status LEDs
- lithium battery accessible behind the front flap
- protection class IP 20
- operating temperature 0...55 °C.

## 2.2 Appropriate Use

The C6925 Industrial PC is designed for mounting in control cabinets for machine and plant engineering applications.

 <p><b>Danger</b></p>	<p><b>Risk of explosion!</b></p> <p>The Industrial PC must not be used where there is a risk of explosion.</p>
--	--

## 2.3 Access to the CFast-Card and the Battery

Access to the CFast-Card and the battery

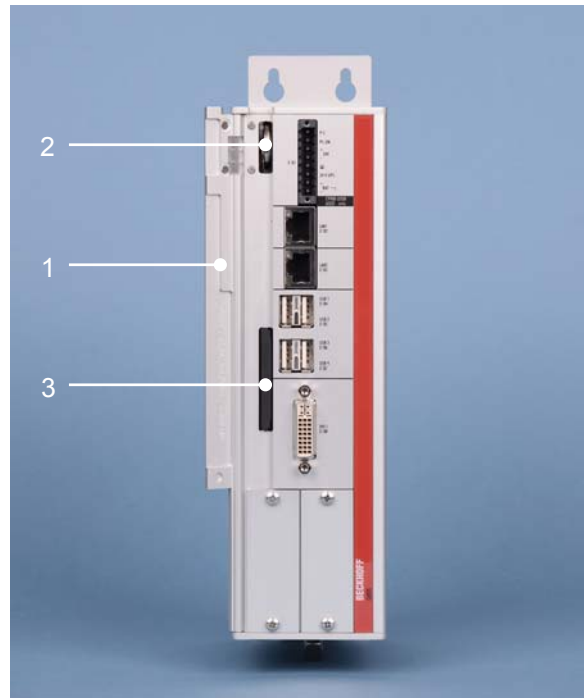

Opening the front flap (1) allows access to the battery (2) and the CFast-Card (3).

 <p><b>WARNING</b></p>	<p><b>Danger of Explosion!</b></p> <p>Replace battery only with the identical type or an alternative type recommended by the manufacturer. Notice correct polarity!</p>
---	---

**Polarity of the battery:**

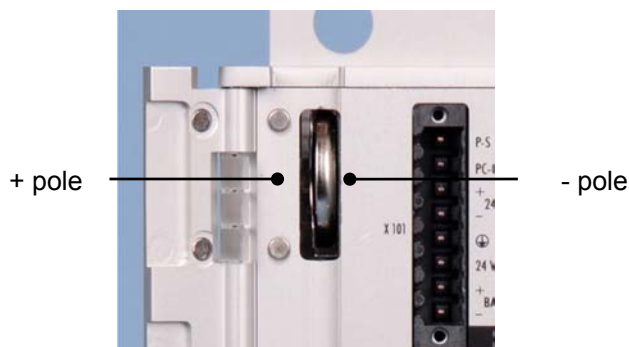

## 2.4 Status-LEDs

The Status-LEDs (2) are located near the power supply connector (X101):

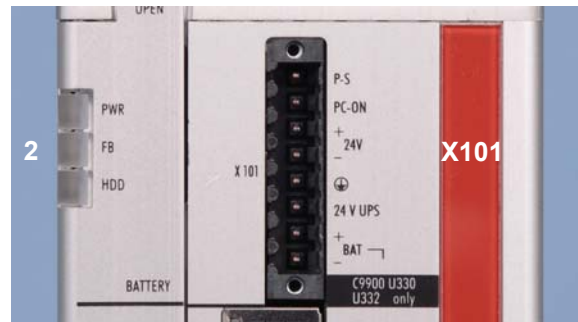

Description of the Status-LEDs:

1	PWR (Power):	green green blinking	Busy Standby
2	FB:	green red	Active Not active
3	HDD:	red	Access to a memory device

## 2.5 Interfaces

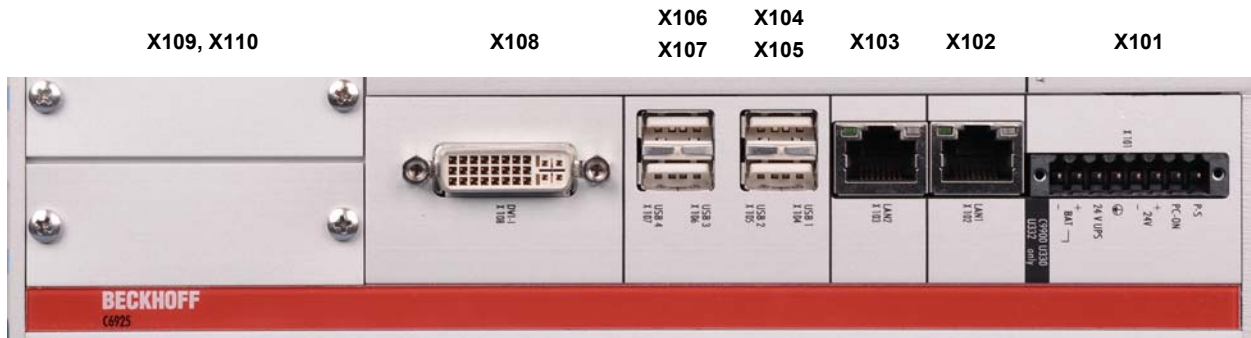

### 2.5.1 Power Supply (X101)

The power supply for the Industrial PC is established via the socket (X101).

### 2.5.2 Network connection (X102, X103)

The RJ-45 connectors (X102, X103) allow the PC to be connected to a 100/1000 BASE-T Local Area Network (LAN).

### 2.5.3 USB-Interfaces (X104 – X107)

The four USB interfaces (X104 – X107) are used for connecting peripheral devices with USB connection. USB2.0 standard is supported.

### 2.5.4 DVI (Digital Visual Interface) (X108)

The DVI connection (X108) is used for transferring the video signal. DVI-I standard is supported.

### 2.5.5 PCIe Module Slots (X109, X110)

Behind the two cover plates (X109, X110) the Industrial PC has 2 PCIe module slots to plug-in Beckhoff PCIe modules or to lead out interfaces of the motherboard ex factory

### 2.5.6 Earthing connection

The earthing connection is located at the mounting plate of the Industrial PC .



## 3 Installation

### 3.1 Transport and Unpacking

The specified storage conditions must be observed (see chapter [Technical Data](#)).

#### 3.1.1 Transport

Despite the robust design of the unit, the components are sensitive to strong vibrations and impacts. During transport, the Industrial PC should be protected from excessive mechanical stress. Therefore, please use the original packaging.

**Attention****Danger of damage to the unit**

If the device is transported in cold weather or is exposed to extreme variations in temperature, make sure that moisture (condensation) does not form on or inside the device.

Prior to operation, the unit must be allowed to slowly adjust to room temperature. Should condensation occur, a delay time of approximately 12 hours must be allowed before the unit is switched on.

#### 3.1.2 Unpacking

Proceed as follows to unpack the unit:

1. Remove packaging.
2. Do not discard the original packaging. Keep it for future relocation.
3. Check the delivery for completeness by comparing it with your order.
4. Please keep the associated paperwork. It contains important information for handling the unit.
5. Check the contents for visible shipping damage.
6. If you notice any shipping damage or inconsistencies between the contents and your order, you should notify Beckhoff Service.

## 3.2 Installation of the PC in the control cabinet

The C6925 Industrial PC is designed for mounting in control cabinets for machine and plant engineering applications.

The ambient conditions specified for operation must be observed (see chapter [Technical Data](#)).

### 3.2.1 Preparation of the control cabinet

Four holes for the fixing bolts have to be provided in the control cabinet according to the dimensions of the PC (see chapter [Assembly dimensions](#)).

	<p><b>Circulation of air</b></p> <p>When the unit is installed in an enclosure, adequate space for ventilation and for opening the PC must be provided.</p> <p>The clearance above and below the housing must be at least 5 cm in order to ensure adequate ventilation of the PC.</p>
---	---

	<p><b>Avoid extreme environmental conditions</b></p> <p>Extreme environmental conditions should be avoided as far as possible. Protect the PC from dust, moisture and heat.</p> <p>The ventilation slots of the PC must not be covered.</p>
---	---

### 3.2.2 Earthing measures





Earthing connections dissipate interference from external power supply cables, signal cables or cables to peripheral equipment.

Establish a low-impedance connection from the earthing point on the PC housing to the central earthing point on the control cabinet wall, in which the computer is being installed. The earthing connection is located at the mounting plate of the Industrial PC.

### 3.3 Power supply of the Industrial PC

The Industrial PC is optionally fitted with a 24 V<sub>DC</sub> power supply unit .

 <b>Note</b>	<b>Uninterruptible power supply (UPS)</b> When the Industrial PC is provided with a power supply unit with integrated UPS (order option) you can realize an uninterruptible power supply (UPS) using the battery pack C9900-U330 or C9900-U332.
--	--

 <b>WARNING</b>	<b>Danger of Explosion!</b> Danger of Explosion if using other battery packs!
---	--

#### 3.3.1 Beckhoff power supply technology

Schematic diagram of power supply unit wirings

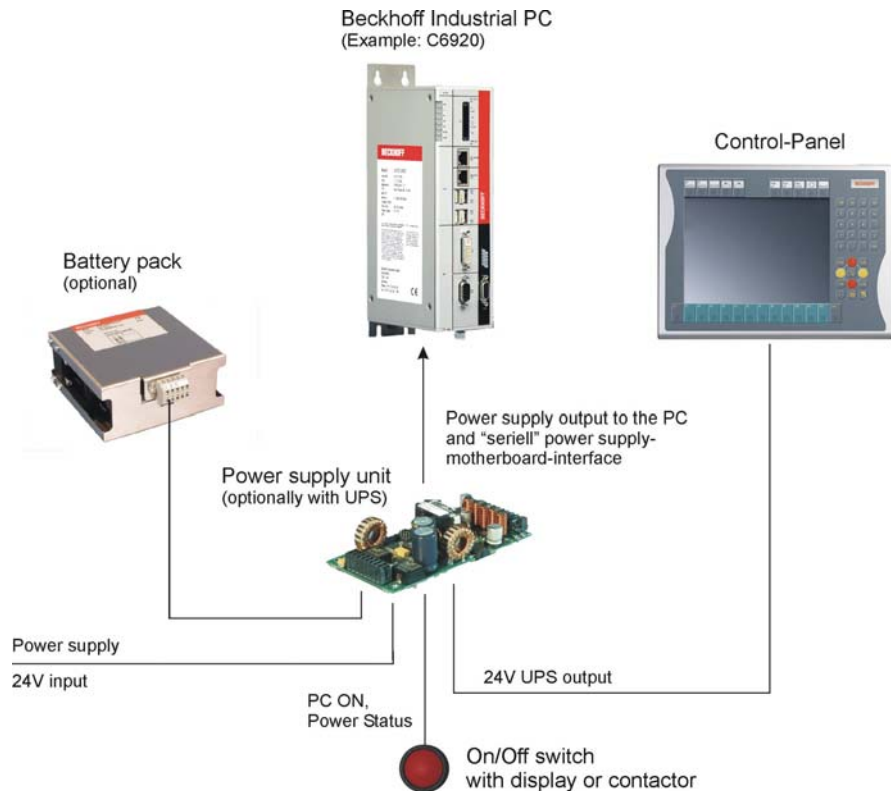

Industrial PCs equipped with a UPS are in actual use frequently switched off by simply turning off the supply voltage. In this case the PC shuts down via the battery. However, over time this reduces the service life of the battery.

The new Beckhoff power supply technology approach addresses this problem and now offers the user the option of switching the PC off without the need for using the battery, thereby reducing the load on the battery.

In addition to the main switch this innovative solution uses an ON/OFF switch for the machine. Basically, the main switch remains switched on and provides the power supply for the PC during shutdown. Via the PC ON-input of the power supply the PC gets the command to shut down the operating system.

Once the PC has shut down, the PC power supply unit sets the Power Status-output (P-S) to 0, what indicates that the process is complete and that the main voltage can be switched off. This can be done manually via a signal lamp connection or via a contactor. With this solution the main switch generally only has to be switched off if the control cabinet has to be opened. The battery will only be used in the event of

a power failure.

In order to maintain a screen display for the Industrial PC in the event of a power failure, the power supply unit is equipped with a UPS output 27 V / 1.4 A for connecting a Control Panel with a display dimension up to 19 inches. This enables a power failure to be visualized and displayed to the user. Once the PC has shut down, the UPS output is switched off.

For a detailed functional description please refer to section [Connecting Power Supply](#).

### 3.3.1.1 Pin assignment of the connector

The power supply and the external circuit for switching the Industrial PC on and off are connected via the 8-pole plug connector.



1 2 3 4 5 6 7 8

Pin assignment for connecting the switch, the power supply and the battery pack (optional):

Pin	Function	
1	-	Battery Pack (with UPS only)
2	+	
3	UPS+ (Output)	
4	⊕	
5	-	24 V DC Power Supply
6	+	
7	PC_ON	
8	Power-Status	



### 3.3.2 Fitting the cable

Fit the cables for the power supply of the Industrial PC, the connection of the battery pack as well as the connection of the power-switch in accordance with the wiring diagram, using the included material for assembling the connectors.

#### 3.3.2.1 Material for assembling the connectors

Plug connector 8-pole, Strain relief housing with lacing cord

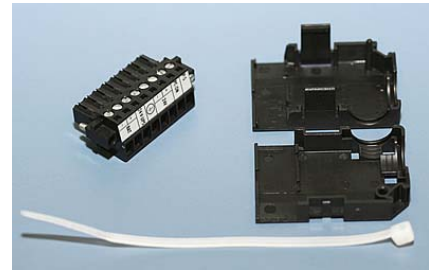

#### 3.3.2.2 Assembling the connectors

The connector is specified for 16 A and can lift conductive cross-sections until 1.5 mm<sup>2</sup>.

So the connector is fitted to the cable:

1. Strip insulation from the cable ends (Length of stripped conductor is 8 – 9 mm).
2. Screw together the cable ends in the 8-pole plug connector in accordance with wiring diagram.

Thread the lacing cord into that lower part of the strain relief housing.



Put the plug connector into that lower part of the strain relief housing.

Tighten the lacing cord and pinch off the plastic strap.

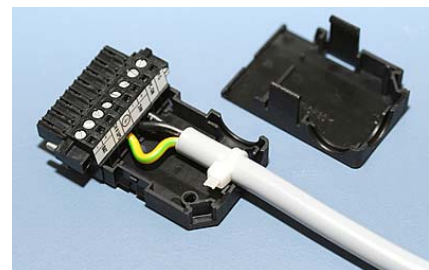

Fix the upper part of the strain relief housing by snapping it onto the lower part.



### 3.3.3 Connecting Power Supply

The external wiring consists of the connection of the power supply, the battery pack (optional) and the connection of customized components for shutting down the PC.

#### 3.3.3.1 Cable Cross Sections

For the connection of the power supply, wiring with a cable-cross-section of  $1.5 \text{ mm}^2$  must be used.

With bigger distances between voltage source and PC, you take the voltage drop as a function of the cable-cross-section as well as voltage fluctuations of your distribution voltage into account, so that is secured that the voltage doesn't fall under 22 V at the power supply.

 <b>Attention</b>	<p><b>Insert fuse</b></p> <p>The power supply must be protected with maximum 16 A.</p>
---	--

#### 3.3.3.2 Configuration for shutting down the PC

The connections for shutting down the Industrial PCs are established via the **PC\_ON** input and the **Power Status** output.

#### 3.3.3.3 PC\_ON and Power Status functions

- If the **PC\_ON** input is connected to 24 V via a switch, the PC shuts down according to the rules. The **PC\_ON** signal is inverted, i.e. the PC shuts down if the 24 V connection is live.
- If the **PC\_ON** input is *NOT* connected by the user, the PC can be booted in the familiar way by connecting the supply voltage and shut down via the battery by switching off the supply voltage.

 <b>Attention</b>	<p><b>Service life of the rechargeable battery</b></p> <p>This procedure significantly reduces the service life of the rechargeable battery and should therefore not be used.</p>
---	---

- Once the PC has shut down, the **Power Status** output is switched from 24 V to 0 V. Via this output a signal lamp can be connected or a contactor for de-energizing the whole system. The maximum load for the **Power Status** output is 0.5 A and a suitable fuse should be provided.

#### 3.3.3.4 UPS output

In order to maintain a screen display for the PC in the event of a power failure, the power supply unit is equipped with a **UPS output** for connecting a Control Panel. The maximum load for the output is 1.4 A.

#### 3.3.3.5 UPS output function

- The 24 V DC connection at the UPS output is live even after a power failure. The maximum load is 1.4 A.
- Once the PC has been de-energized via the UPS software, the **UPS output** is switched to 0 V. Any connected panel is thus switched off, and total discharge of the rechargeable battery is prevented.

### 3.3.3.6 Wiring diagram

Wiring according to the wiring diagram (the circuit of PC\_ON and Power-Status is symbolical):

Wiring diagram external switch and power supply

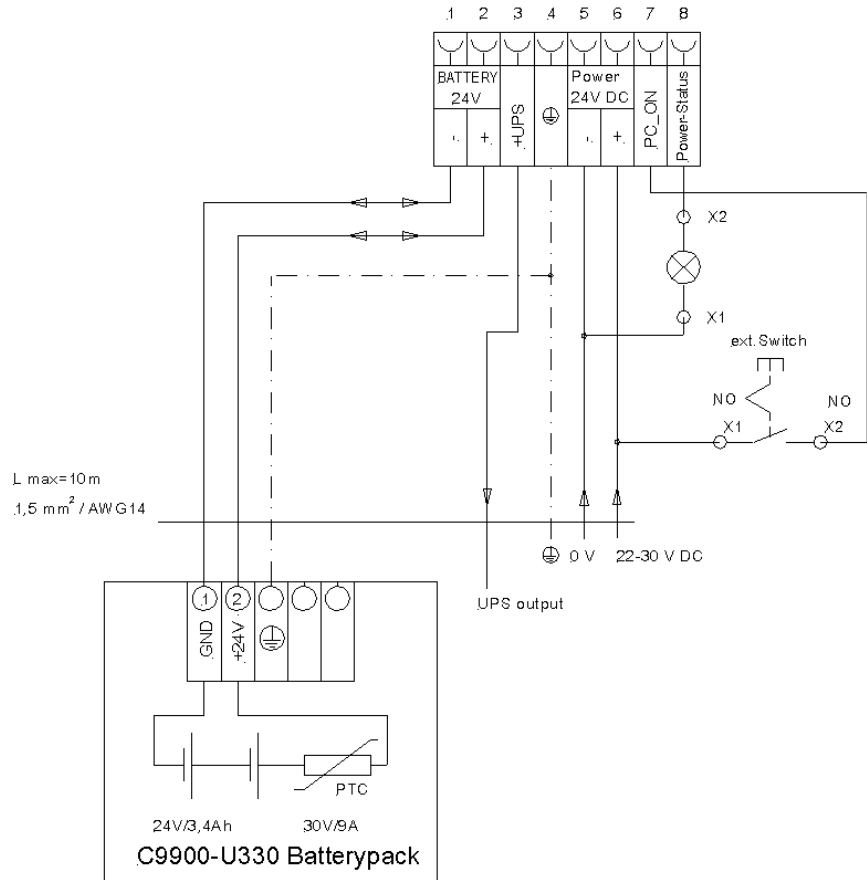

 <b>Note</b>	<p><b>Connection of the Battery Pack and UPS Output</b></p> <p>Connection of the Battery Pack and UPS Output only in combination with integrated UPS (order option).</p>
--	--

## 3.4 Connecting the Industrial PC

 <b>Attention</b>	<p><b>The mains plug must be disconnected</b></p> <p>The power supply plug must be withdrawn!</p> <p>Please read the documentation for the external devices prior to connecting them!</p> <p>During thunderstorms, plug connector must neither be inserted nor removed!</p> <p>When disconnecting a plug connector, always handle it at the plug. Do not pull the cable!</p>
---	--

### 3.4.1 Connecting cables

The connections are located at the rear side of the Industrial PC and are documented in the [Product Description](#) chapter.

When connecting the cables to the Industrial PC, proceed according to the following sequence:

- Switch off all the devices that are to be connected.
- Disconnect all the devices that are to be connected from the power supply.
- Connect all the cables between the Industrial PC and to the devices that are to be connected.
- Connect all data transfer cables (if present) to the appropriate plug-in receptacles of the data/telecommunication networks.
- Reconnect all devices to the power supply.

### 3.4.2 Check voltage rating and connect

**Fitted with a 24 V<sub>DC</sub> power supply unit:**

1. Check that the external power supply is providing the correct voltage.
2. Insert the power supply cable that you have assembled into the Industrial PC's power supply socket. Then connect it to your external 24 V power supply.

 <b>Attention</b>	<p><b>Use same type of rechargeable battery</b></p> <p>If a 24 V UPS is installed, the same type of rechargeable battery must be used.</p>
---	--

## 4 Operating Instructions

### 4.1 Switching the Industrial PC on and off



#### 4.1.1 Switch on

The Industrial PC does not have its own mains switch. The Industrial PC will start when the equipment is switched on, or when it is connected to the power supply.

#### 4.1.2 Shutting down and switching off

When the plant is switched off, or when it is disconnected from its power supply, the Industrial PC will be switched off.

Control software such as is typically used on Industrial PCs permits various users to be given different rights. A user who may not close software may also not switch the Industrial PC off, since data can be lost from the hard disk by switching off while software is running.

 <p><b>Attention</b></p>	<p><b>First shut down, then switch off the PC</b></p> <p>If the Industrial PC is switched off as the software is writing a file to the memory drive, the file will be destroyed. Control software typically writes something to the memory drive every few seconds, so that the probability of causing damage by switching off while the software is running is very high.</p>
 <p><b>Attention</b></p>	<p><b>Switch off power supply</b></p> <p>When you have shut down the Industrial PC, you have to switch off power supply for at least 10 seconds before rebooting the system.</p> <p>After resetting power supply the PC will start booting automatically.</p>

#### 4.1.3 First switching on and driver installation

When you switch on the Industrial PC for the first time, the pre-installed operating system (optional) will be started. In this case, all the required drivers for any additional, optional hardware components ordered with the PC will already have been installed.

If the PC was ordered without operating system, you have to install the operating system and the driver software for any auxiliary hardware yourself. Please follow the instructions in the documentation for the operating system and the additional devices.

## 4.2 Servicing and maintenance

### 4.2.1 Cleaning of the Industrial PC

 <b>DANGER</b>	<p><b>Disconnect power supply</b></p> <p>Switch off the Industrial PC and all connected devices, and disconnect the Industrial PC from the power supply.</p>
--	--

The device can be cleaned with a soft, damp cleaning cloth. Do not use any aggressive cleaning materials, thinners, scouring material or hard objects that could cause scratches.

### 4.2.2 Maintenance

The Industrial PC is maintenance-free.

### 4.2.3 Replacing the Battery on the Motherboard

A used battery on the motherboard has to be replaced. See also chapter [Access to the CFast-Card and the Battery](#).

 <b>WARNING</b>	<p><b>Danger of Explosion!</b></p> <p>Replace battery only with the identical type or an alternative type recommended by the manufacturer. Notice correct polarity!</p>
---	---

The used battery must be disposed of in accordance with national electronics scrap regulations.

## 4.3 Emergency procedures

In case of fire, the Industrial PC should be extinguished with powder or nitrogen.

## 4.4 Shutting down

### 4.4.1 Disposal

 <b>Note</b>	<p><b>Observe national electronics scrap regulations</b></p> <p>Observe the national electronics scrap regulations when disposing of the device.</p>
--	--

In order to dispose of the device, it must be removed and fully dismantled:

- Housing components (polycarbonate, polyamide (PA6.6)) are suitable for plastic recycling
- Metal parts can be sent for metal recycling
- Electronic parts such as disk drives and circuit boards must be disposed of in accordance with national electronics scrap regulations.

## 5 UPS Software Components (optional)

For operating the power supply unit as a UPS, the UPS driver software and the associated UPS driver must be installed on the Industrial PC.

On delivery of the Beckhoff Industrial PC with operating system the software is already installed. Should the software not be installed on your PC, the drivers can be installed from the driver CD provided.

### 5.1 Installation on the PC

To install the UPS driver software, execute file **Beckhoff\_UPS\_vx.xx.xx.exe** from the subdirectory of **UPS\...** from the CD provided on the Industrial PC (Driver-archive for the Industrial-PC, C9900-S700-xxxx).

The program is self-extracting and will guide the user through the installation routine.

### 5.2 Help files

The driver software comes with a detailed help function.

The help files can be called up either directly from the configuration register by clicking the Help button, or under via *Start > Programs > Beckhoff > UPS software components*.

## 6 Troubleshooting

Fault	Cause	Procedure
Nothing happens after the Industrial PC has been switched on	No power supply to the Industrial PC  Other cause	Check power supply cable  Call Beckhoff Service
The Industrial PC does not boot fully	Setup settings are incorrect  Other cause	Check the setup settings  Call Beckhoff Service
Computer boots, software starts, but control does not operate correctly	Cause of the fault is either in the software or in parts of the plant outside the Industrial PC	Call the manufacturer of the machine or the software
Memory device access error	Faulty device	Call Beckhoff Service
The Industrial PC functions only partially or only part of the time, e.g. no or dark picture, but disk drive responds when switching on	Defective components in the Industrial PC	Call Beckhoff Service



## 7 Assembly dimensions

### Industrial PC C6925

For the assembly dimensions of the Industrial PC please visit our homepage. Here you will find the actual drawings using the link:

[http://www.beckhoff.de/german/download/technical\\_drawings.htm](http://www.beckhoff.de/german/download/technical_drawings.htm)



**Warning**

#### **Notice mounting orientation**

The assembly of the unit must take place with the orientation diagrammed here.

## 8 Technical Data

 <p><b>Danger</b></p>	<p><b>Risk of explosion!</b></p> <p>Do not use the Industrial PC in areas of explosive hazard!</p>
--	--

<b>Product name</b>	<b>C6925</b>
Dimensions (B x H x T)	see chapter <a href="#">Assembly dimensions</a>
Weight	1.75 kg (basic configuration)
Supply voltage	22–30V V <sub>DC</sub> (24 V <sub>DC</sub> power supply unit)
Power consumption	C6925-0020: app. 25 W (basic configuration) C6925-0030: app. 14 W (basic configuration)
Interfaces	1 x DVI-I 2 x RJ-45 100/1000 BASE-T Ethernet 4 x USB 2.0
Protection class	IP20
Shock resistance (Sinusoidal vibration)	EN 60068-2-6: 10 to 58 Hz: 0,035 mm 58 to 500 Hz: 0,5 G (~ 5 m/ s <sup>2</sup> )
Shock resistance (Shock)	EN 60068-2-27: 5 G (~ 50 m/ s <sup>2</sup> ), duration: 30 ms
EMC compatibility	Resistance to interference conforms to EN 61000-6-2
EMC compatibility	Emission of interference conforms to EN 61000-6-4
Permissible ambient temperature	0°C to +55°C (operation) -25°C to +65°C (transport/ storage)
Permissible relative humidity	to 95%, no condensation
Transport and storage	The same values for atmospheric humidity and shock resistance are to be observed during transport and storage as in operation. Suitable packaging of the Industrial PC can improve the resistance to impact during transport.
Certifications	CE

## 9 Appendix

### 9.1 Beckhoff Support and Service

Beckhoff and their partners around the world offer comprehensive support and service, making available fast and competent assistance with all questions related to Beckhoff products and system solutions.

#### 9.1.1 Beckhoff branches and partner companies

Please contact your Beckhoff branch office or partner company for [local support and service](#) on Beckhoff products!

The contact addresses for your country can be found in the list of Beckhoff branches and partner companies: [www.beckhoff.com](http://www.beckhoff.com). You will also find further [documentation](#) for Beckhoff components there.

#### 9.1.2 Beckhoff company headquarters

Beckhoff Automation GmbH & Co. KG  
Huelshorstweg 20  
33415 Verl  
Germany

Phone: + 49 (0) 5246/963-0  
Fax: + 49 (0) 5246/963-198  
E-mail: [info@beckhoff.de](mailto:info@beckhoff.de)  
Web: <http://www.beckhoff.de/>

#### Beckhoff Support

Support offers you comprehensive technical assistance, helping you not only with the application of individual Beckhoff products, but also with other, wide-ranging services:

- world-wide support
- design, programming and commissioning of complex automation systems
- and extensive training program for Beckhoff system components

Hotline: + 49 (0) 5246/963-157  
Fax: + 49 (0) 5246/963-9157  
E-mail: [support@beckhoff.com](mailto:support@beckhoff.com)

#### Beckhoff Service

The Beckhoff Service Center supports you in all matters of after-sales service:

- on-site service
- repair service
- spare parts service
- hotline service

Hotline: + 49 (0) 5246/963-460  
Fax: + 49 (0) 5246/963-479  
E-mail: [service@beckhoff.com](mailto:service@beckhoff.com)

If servicing is required, please quote the **project number** of your product.

## 9.2 Approvals for USA and Canada

### 9.3 FCC Approvals for the United States of America

**FCC: Federal Communications Commission Radio Frequency Interference Statement**

This equipment has been tested and found to comply with the limits for a Class A digital device, pursuant to Part 15 of the FCC Rules. These limits are designed to provide reasonable protection against harmful interference when the equipment is operated in a commercial environment. This equipment generates, uses, and can radiate radio frequency energy and, if not installed and used in accordance with the instruction manual, may cause harmful interference to radio communications. Operation of this equipment in a residential area is likely to cause harmful interference in which case the user will be required to correct the interference at his own expense.

**Note****Technical modifications**

Technological changes to the device may cause the loss of the FCC approval.

### 9.4 FCC Approval for Canada

**FCC: Canadian Notice**

This equipment does not exceed the Class A limits for radiated emissions as described in the Radio Interference Regulations of the Canadian Department of Communications.