

The QuickStep motor. Step motors with inte- grated driver MIS231, MIS232, MIS234



The QuickStep series of Stepper motors with integrated electronics represents a major step forward. All the necessary electronics in a stepper system are integrated in the motor itself.

In the past, a traditional motor system has typically been based on a central controller unit located remote from the motor. This configuration however has the negative effect that installation costs are a major part of the total expense of building machinery.

The basic idea of the QuickStep motors is to minimize these costs but also to make a component that is much better protected against electrical noise

which can be a typical problem when using long cables between the controller and motor.

The stepper motor, encoder and electronics are specially developed by JVL so that together they form a closed unit in which the power driver and controller are mounted inside the motor in a closed section.

The advantages of this solution are:

- De-central intelligence.
- Simple installation. No cables between motor and driver.
- EMC safe. Switching noise remains within motor.
- Compact. Does not take space in cabinet.

- 12-48VDC power.
- Low-cost alternative to separate step or servo motor and driver.

Interface possibilities to the QuickStep motor:

- From PC/PLC with serial commands via RS485.
- Pulse/direction input. Encoder output.
- Option for μ PLC built-in with graphical programming.
- CANopen, DeviceNet
- 8 I/O, 5-28VDC that can be configured to Inputs, Outputs or analogue inputs
- Future option for Profibus DP, Ethernet, Bluetooth and Zigbee wireless

Quickstep is a new series of motors from JVL which can be delivered with a large selection of functions and in a wide variety of combinations. The base is a hightorque NEMA23 step motor with a housing so that IP55 or larger protection can be achieved. One or more circuit cards and different connectors can be mounted in the housing to adapt the motor to a given task.

Also available: Step motor without electronics. Optional with encoder. All modules can be delivered with M12, cable glands or, by larger orders, connector chosen by customer. 1,1Nm, 1,6Nm or 2,9Nm versions Backlash free and planetary gears in ratios of 3, 5, 10, 20, 100 can be delivered from stock.

Pulse/direction

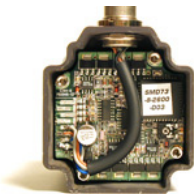

- Pulse/direction driver
- 200, 400, 800, 1000 or 1600 pulse/rev. resolutions.

- Input for pulse/direction signal 5-24VDC PNP/NPN.
- The driver is the wellknown SMD73.
- Supply voltage is 12 - 28VDC
- Can also be delivered as box driver without motor.

Positioning or Speed Control



- Serial RS485 or 5V serial position controller
- Position controller with grafic programming, Canbus, CANopen 402 or DeviceNet
- Stall detect by means of magnetic encoder with resolution of up to 1024 pulses/rev.
- A double supply facility is available so that position and parameters are maintained at emergency stop
- Gear mode

- MACmotor protocol so MACmotor and Quickstep motors can be connected on the same RS485 bus
- Command for easy PLC/PC setup and communication
- Power supply 12-48VDC
- Fixed 1600 pulses/rev.
- Can also be delivered as box controller without motor.

Built-in μ processor with 8 In/Out that can be configured as inputs, PNP outputs or analogue inputs. RS485 interface for set up and programming. Option for CANbus, CANopen 402 or Devicenet. Driver technology is improved as compared to SMD73 and supply voltage is 12-48VDC.



M12 Connector

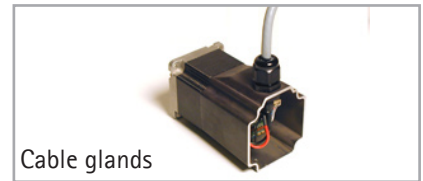

Cable glands

System and Feature Overview

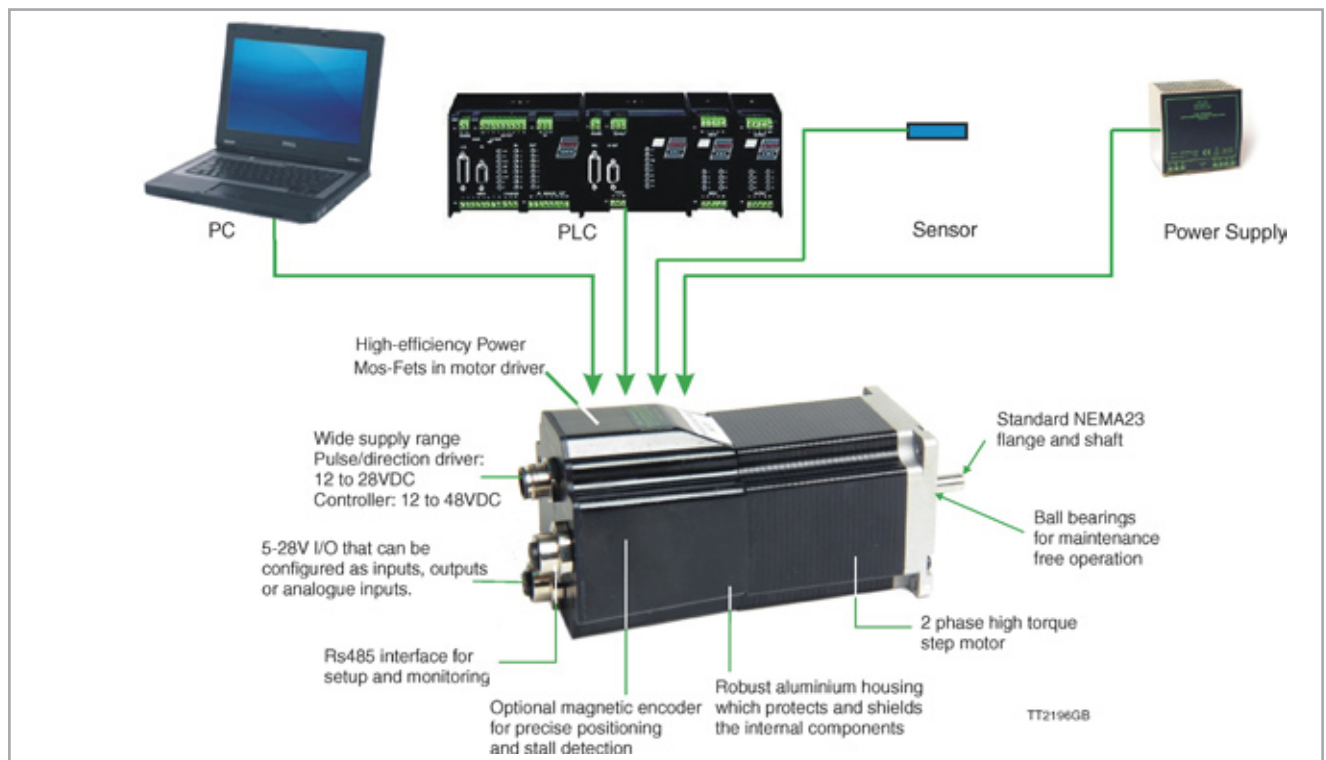

Modes of Operation

Positioning and Velocity Mode

In this mode the QuickStep motor positions the motor via commands sent over the serial interface. Various operating parameters can be changed continuously while the motor is running. This mode of operation is used primarily in systems where the Controller is permanently connected to a PC/PLC via the interface. This mode is also well suited for setting up and testing systems. The mode is also used when programming is made.

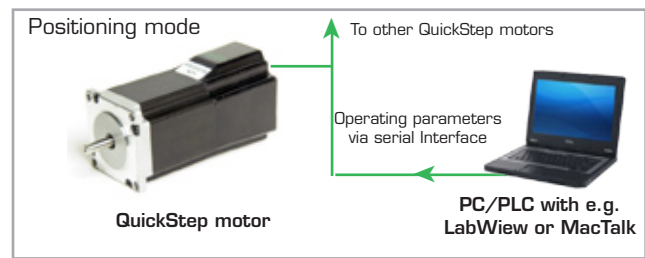

Gear Mode

In this mode the QuickStep motor functions as in a step motor driver. The motor moves one step each time a voltage pulse is applied to the step-pulse input. Velocity, acceleration and deceleration are determined by the external frequency, but can be limited and controlled by the QuickStep motor. In addition, the QuickStep motor also provides a facility for electronic gearing at a keyed-in ratio.

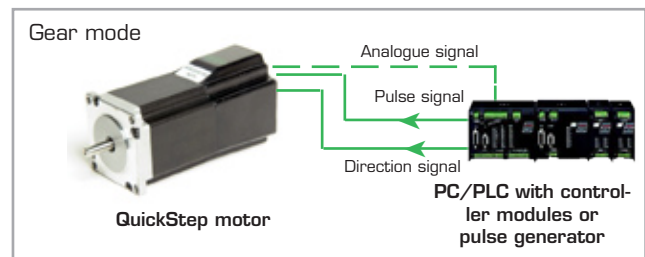

Serial Mode

In this mode the QuickStep motor's registers contain the positions, velocities, accelerations, etc., required for the actual system. The registers can be selected and executed by a single byte sent via the serial interface. This mode provides maximum utilisation of the QuickStep motor's features since the QuickStep motor itself takes care of the entire positioning sequence.

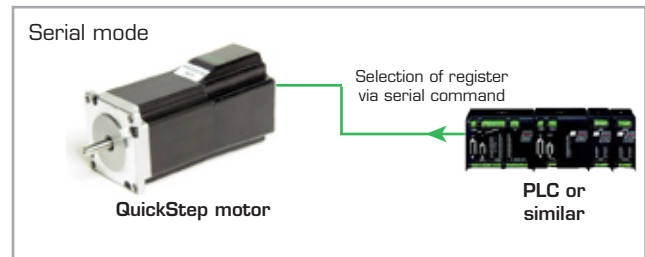

Block Diagrams

Pulse/Direction version

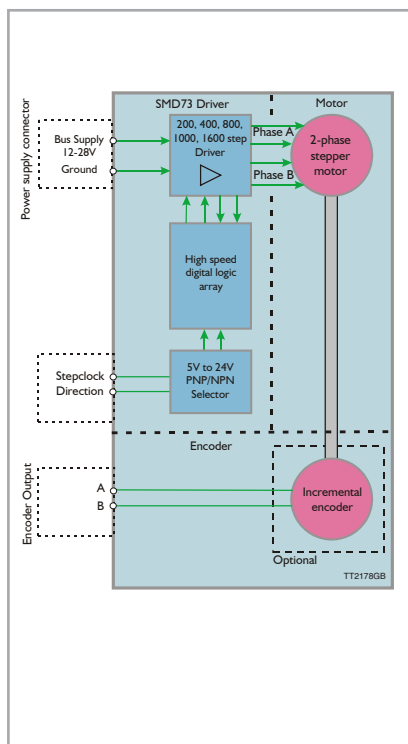

Positioning/Speed Control version

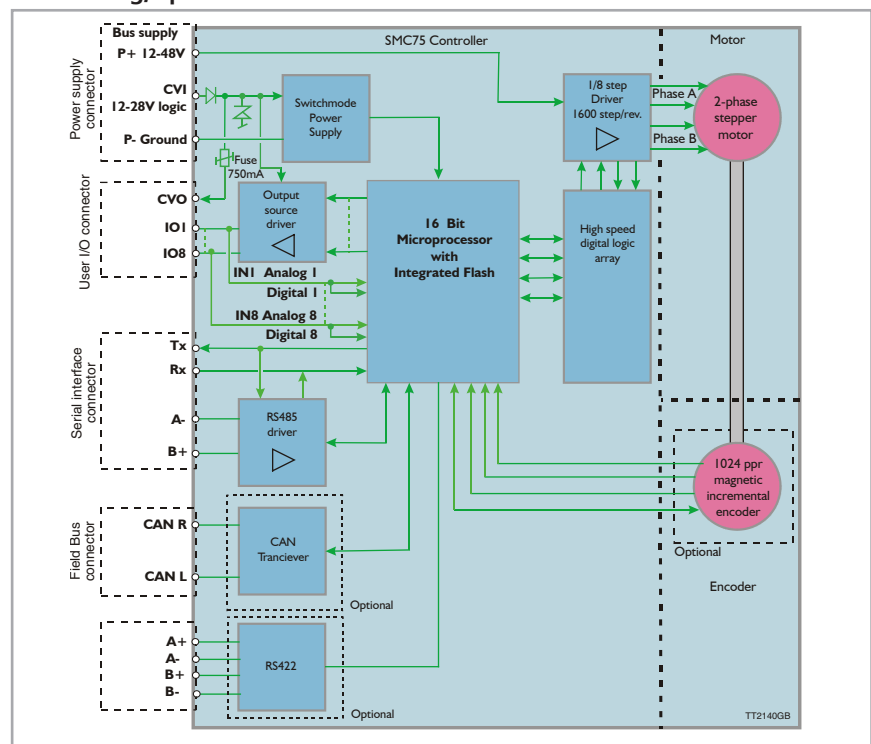

Setup and programming with software MacTalk

Setup save/open
The complete setup can be either saved or reloaded from a file using these buttons

Startup mode
The basic functionality of the unit is setup in this field.

Profile Data
All the main parameters for controlling the motor behaviour are setup in this field.

Driver Parameters
These fields are used to define standby and running current.

Gear Factor
The gear ratio can be entered here

Motion Parameters
The distance the motor has to run is entered here

System control
Use these buttons to save data permanently, reset the motor etc.

Error Handling
Use these fields to define error limits for the position range etc.

Motor status
This field shows the actual motor load, position and speed etc.

Run status
Shows what the status of the motor is. The Bus voltage for the motor and the temperature of the driver is also shown

Inputs
The status of the digital inputs are shown her and the analogue value

Outputs
The status of the outputs are shown here and can be activated by the cursor

Errors
If a fatal error occurs, information will be displayed here.

Warnings
Here different warnings are shown

Help Line
Left area: If parameters entered are outside their normal values, errors are shown here.
Right area: Here it is possible to see if a motor is connected, the type, version and serial no.

Zero Search
All the parameters regarding the position zero search can be specified here.

Autocorrection
The parameters used to get the correct position, if it is a motor with encoder

Communication
The actual address of the motor can be entered here

TT2145GB

MacTalk introduction

The MacTalk software is the main interface for setting up the QuickStep motor for a specific application. The program offers the following features:

- Choice of the operating mode of the QuickStep motor.
- Changing main parameters such as speed, motor current, zero search

type, etc.

- Monitoring the actual motor parameters in real time, such as supply voltage, input status, etc.
- Changing protection limits such as position limits.
- Saving all current parameters to disc.
- Restoring all parameters from disc.
- Saving all parameters permanently

in the motor.

- Updating the motor firmware or MacTalk software from the internet or a file.

The main window of the program changes according to the selected mode, thus only showing the relevant parameters for operation in the selected mode.

Command toolbox description

The toolbox used for the programming covers 14 different command types. The idea for the commands - is to have an easy access to the most common functions in the motor. Some functions seems to be missing by the first sight but the botton "Set register in the QuickStep motor" or "Wait for a register value before continueing" gives direct access to +50 registers down in the basic QuickStep motor such as the gear ratio or the actual torque register. In total this gives a very power full programming tool since >95% of a typical program can be build using the simple command icons and the last part is optained by accessing the basic motor registers directly. Below is a short description of all 14 command icons.

Use: Initiates any motor movement relative or absolute.

Use: Inserts a remark/ Comment in the program source code.

Use: Set the motor in the desired mode such as position- or velocity mode.

Use: Set a certain state at one or multiple digital outputs.

Use: Unconditional jump from one program line to another.

Use: Conditional jump from one program line to another. Input dependent

Use: Inserts a delay in the program specified in milliseconds.

Use: Wait for (x)ms before continuing

Use: Wait for an input combination before continuing

Use: Wait for a certain state at one or multiple digital inputs.

Use: Write a value to almost any register in the basic unit.

Use: Jump according to a register in the MAC icota

Use: Conditional jump from one program line to another. Register dependent

Use: Wait for a certain state at one or more of the digital inputs.

Use: Initiates a zero search to a sensor or a torque (no sensor).

Use: Preset the position counter to a certain value.

Use: Save the actual motor position to an intermediate register.

TT0987GB

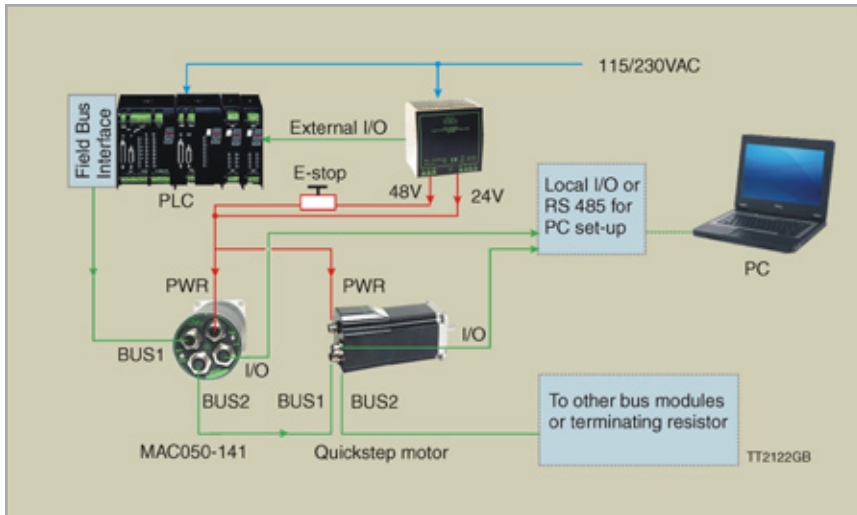

Quickstep and MAC motor in an RS485 or CANbus network

Torque versus speed

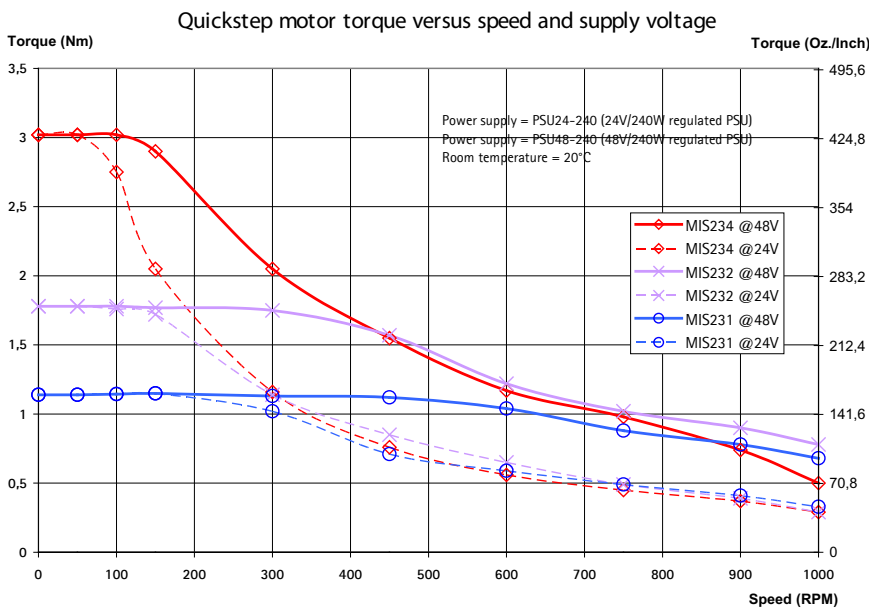

Motor Specifications

| Motor Type | MIS231 | MIS232 | MIS234 | Unit |
|--------------|--------|--------|--------|-------------------|
| Max. Speed | 1000 | 1000 | 1000 | RPM |
| Rated Torque | 1.1 | 1.6 | 2.9 | Nm |
| Inertia | 0.3 | 0.48 | 0.96 | kgcm ² |
| Length | 96.0 | 118.5 | 154.0 | mm |
| Weight | 0.9 | 1.2 | 1.8 | kg |

Accessories

RS485-M12-1-5 cable for M12, 5pin to RS485 USB. 5m



RS485-USB-ATC-820 USB to RS485 adaptor. 0.5m



WI1000-M12xxVxxN M12, angled female/male cable can be delivered. See cable data-sheet for details.



WI1000-M12xxTxxN M12, straight female/male cable can be delivered. See cable data-sheet for details.



PSU24-075 PSU 24VDC/3.2A, 75W. 85-264VAC DIN Switch-mode power supply. UL/CE approved. DIN rail. HxDxW = 126x100x56mm.



PSU48-240. PSU48VDC/5A. 240W. 100-240 VAC Switch-mode power supply. UL/CE approved. DIN rail. HxDxW = 126x100x126mm.

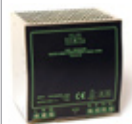

MAB23X-03. Brake 24V for NEMA23. ø6.35. M8/5m



MacTalk MAC motor Windows software for setup and programming



MacRegio Windows software for protocol analyses and understanding.



MACCOMM OCX/active x driver for Windows programs



(Position control)

| | Min. | Max. | Absolute Max. | Unit |
|-------------------------|----------|------|---------------|-------|
| P+ | 12 | 48 | - | VDC |
| CVI | 12 | 28 | 32 | VDC |
| CVI no output activated | 95@24VDC | | | mA |
| Motor Current | 0 | 3 | 3 | A RMS |
| Input Logic Low | -0.5 | 0.9 | | VDC |
| Input Logic High | 1.9 | 28 | 32 | VDC |
| Output Logic High | 12 | 28 | 32 | VDC |
| Analogue Input | 0 | 5 | 32 | VDC |
| Output Current | | | 350* | mA |

*8 Outputs: Totally max. 800 mA. for all 8 outputs active

Versions with positioning and speed control:

| QUICKSTEP M12 connector overview | Power Male 5pin | I01-4/RS485 Female 8pin | I05-8 Female 8pin | RS485 Female 5pin | CANOpen/DeviceNet Male 5pin | SSI Encoder Male 8pin | Function |
|----------------------------------|------------------|-------------------------|-------------------|-------------------|-----------------------------|------------------------|----------------------|
| #MIS23xAzM2yy75 | X | | X | | | | RS485, 4IO |
| MIS23xAzM3yy75 | X | | X | X | | | 2xRS485, 4IO |
| #MIS23xAzM4yy75 | X | X | X | | | | RS485, 8IO |
| MIS23xAzM5yy75 | X | X | X | X | | | 2xRS485, 8IO |
| MIS23xAzM6yy75 | X | X | X | | X | | CANOpen, RS485 8IO |
| #MIS23xAzM7yy75 | X | X | X | | X | | Devicenet, RS485 8IO |
| MIS23xAzM9yy75 | X | X | | X | | X | SSI, 6IO |
| M12 Pin 1 | P+ (12-48VDC) | I01 | I05 | B+ (RS485) | CAN_SHLD | I05 Zero Setting | |
| M12 Pin 2 | P+ (12-48VDC) | I02 | I06 | A- (RS485) | CAN_V+ | I06 Counting Direction | |
| M12 Pin 3 | P- (GND) | I03 | I07 | B+ (RS485) | CAN_GND | A+ (Clock+) | |
| M12 Pin 4 | CVI (12-28VDC) | GND IO- | GND IO- | A- (RS485) | CAN_H | GND | |
| M12 Pin 5 | P- (GND) | B+ (RS485) | | GND | CAN_L | B- (Data in-) | |
| M12 Pin 6 | - | A- (RS485) | | - | - | B+ (Data in+) | |
| M12 Pin 7 | - | I04 | I08 | - | - | A- (Clock-) | |
| M12 Pin 8 | - | CVO (Out) | CVO (Out) | - | - | CVO+ (Out) | |
| M12 connector solder terminals | WI1008-M12F5SS1 | WI1008-M12M8SS1 | WI1008-M12M8SS1 | WI1008-M12M5SS1 | WI1008-M12F5SS1 | WI1008-M12M8SS1 | |
| M12 cables 5m. | WI1000-M12F5T05N | WI1000-M12M8T05N | WI1000-M12M8T05N | WI1000-M12M5T05N | WI1006-M12F5S05R | WI1000-M12M8T05N | |

: Only > 50 pcs order . x: 1: 1Nm, 2: 1.6Nm, 3: 2,5Nm. z: 1: 6,35mm shaft 3: 10,0mm shaft (only if x=3) yy:=NO-No encoder. H2~built-in encoder

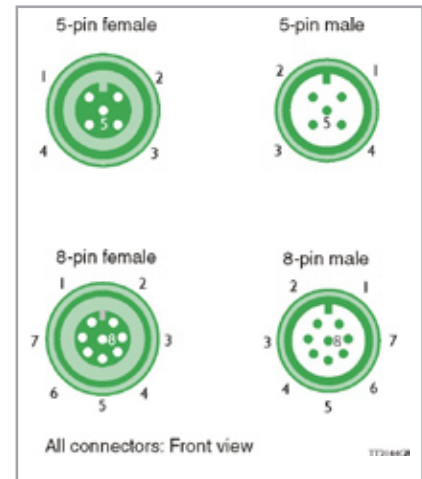
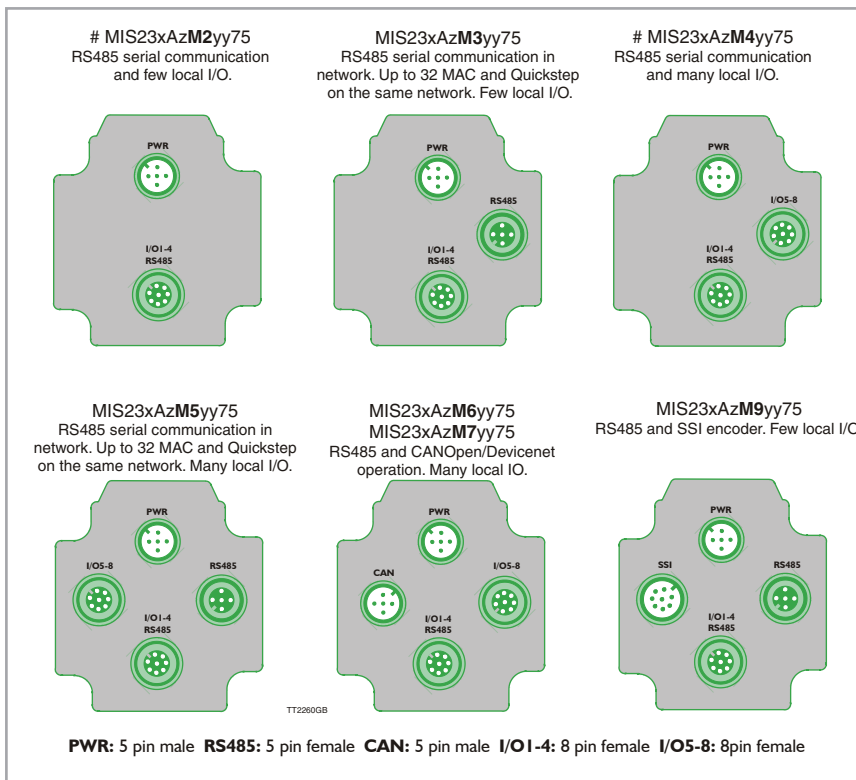

Versions with pulse and direction control:

Connections for versions with 1 pcs M12 connector(See also SMD73 datasheet):

| M12 5pin male | Description |
|---------------|---------------|
| 1 | P+ (18-28VDC) |
| 2 | Pulse |
| 3 | P- |
| 4 | Direction |
| 5 | Signal Ground |

| 5-pole connector | |
|------------------|-------|
| Pin no. | Color |
| 1 | Brown |
| 2 | White |
| 3 | Blue |
| 4 | Black |
| 5 | Grey |

| 8-pole connector | |
|------------------|--------|
| Pin no. | Color |
| 1 | White |
| 2 | Brown |
| 3 | Green |
| 4 | Yellow |
| 5 | Grey |
| 6 | Pink |
| 7 | Blue |
| 8 | Red |

Connections for versions with cable glands and 5 m cable

| Color code | Description |
|------------|---------------|
| Red | P+ (8-28VDC) |
| Black | P- |
| Blue | Direction |
| White | Pulse |
| Shield | Signal ground |

Ordering Information

| Motor type | Size | Generation | IP and shaft | Connection | Feedback | Driver Technology | Step Resolution | mA in driver | Input format | Standby current ratio | |
|--|---------------|--|--------------|------------|----------|-------------------|-----------------|--------------|--------------|--|---|
| MIS | 232 | A | 1 | M2 | NO | 73 | 8 | 10 | E | 3 | |
| | | | | | | | | | | 1 to 31 Standby current ratio(03 = 1/3 standby current) # | |
| | | | | | | | | | | D 24V NPN inputs E 24V PNP inputs F 5V inputs | |
| | | | | | | | | | | xx xx specify mA*100/phase. See SMD73 datasheet | |
| | | | | | | | | | | 0 No driver # 1 1/1 step (with 200 steps/rev. motor 200 pulses/rev.) 2 1/2 step (with 200 steps/rev. motor 400 pulses/rev.) 4 1/4 step (with 200 steps/rev. motor 800 pulses/rev.) 5 1/5 step (with 200 steps/rev. motor 1000 pulses/rev.) 8 1/8 step (with 200 steps/rev. motor 1600 pulses/rev.) | |
| | | | | | | | | | | 73 SMD73 driver 15-28VDC. Pulse and direction driver 74 Driver 12-48VDC based on SMC75 technology. (Future option). 75 SMC75 driver and controller with FLEXMAC protokol. 12-48VDC and optional encoder/hall sensor feedback. (Future option). # 76 Controller based on SMD41 driver and SMC75 indexer functionality. # 41 SMD41 driver technology, 20-80VDC. Pulse and direction driver. (Future option). 42 SMD42 driver technology, 30-160VDC. Pulse and direction driver. (Future option). | |
| | | | | | | | | | | NO No feedback H1 Hall sensor feedback. 32 pulses/rev. Only if driver support this feature (Future option). H2 Hall sensor feedback. 256 pulses/rec. Only if driver supports this feature (from Q4 06) E1 Encoder feedback. 1024 lines = 4096 pulses/rev. Only if driver support this feature. (Future option). | |
| | | | | | | | | | | M1 M12 1pcs. 5pin male . SMD73 pulse/direction driver. M2 M12 2 pcs. 5 pin male (power). 8 pin female (RS485, 4IOA) M3 M12 3 pcs. 5 pin male (power), 8 pin female (RS485, IOA 1-4), 5 pin female (RS485) M4 M12 3 pcs. 5 pin male (power), 8 pin female (RS485, IOA 1-4), 8 pin female (5V serial, IOA5-8) M5 M12 4 pcs. 5 pin male (power), 8 pin female (RS485, IOA 1-4), 5 pin female (RS485), 8 pin female (5V serial, IOA 5-8). M6 M12 4 pcs. 5 pin male (power), 8 pin female (RS485, IOA 1-4), 8 pin female (5V serial, IOA 5-8), 5 pin male (CANopen) M7 M12 4 pcs. 5 pin male (power), 8 pin female (RS485, IOA 1-4), 8 pin female (5V serial, IOA 5-8), 5 pin male (DeviceNet) W0 PG16 and no cable W1 PG16 and 2m cable. Flying leads with shield. EX Long hosing ready for MAC00-xx expansion board (Future option) | |
| | | | | | | | | | | 1 6,35mm shaft and IP42 2 6,35mm shaft and IP55 (motor shaft and body) IP65 (Rear end and connector) 3 10,0 mm shaft and IP42 4 10,0mm shaft and IP55 (motor shaft and body) IP65 (Rear end and connector) 5 14mm shaft and IP42 6 14mm shaft and IP55 (motor shaft and body) IP65 (Rear end and connector) | |
| | | | | | | | | | | A Motordriver for 3,0A/phase B Motordriver for 6A/phase (Future option) | |
| | | | | | | | | | | 230 NEMA23 step motor 231 NEMA23 step motor 232 NEMA23 step motor 234 NEMA23 step motor 340 NEMA34 step motor (From Q4 2006) 341 NEMA34 step motor (From Q4 2006) 342 NEMA34 step motor (From Q4 2006) | |
| MIS | MISxxx | Motor Integrated Stepper motor. | | | | | | | | | |
| Examples | | | | | | | | | | | |
| MIS | 231 A | | 1 | W1 | NO | 73 | 8 | 25 | D | | Motor 6,35 shaft, flying leads, SMD73 driver |
| MIS | 234 A | | 3 | M1 | NO | 73 | 2 | 30 | D | | Motor 10mm shaft, M12 , SMD73 |
| MIS | 232 A | | 1 | M3 | NO | 75 | | | | | Motor 6,35mm shaft. SMC75. 3 pcs M12 connectors |
| MIS | 234 A | | 3 | M6 | NO | 75 | | | | | Motor 10mm shaft. SMC75. 4 pcs M12 connectors, CANopen |
| MIS | 232 A | | 1 | M7 | H2 | 75 | | | | | Motor 6,35mm shaft. SMC75 .4 pcs M12 connectors. DeviceNet. Encoder H2 option |
| MIS | 340 B | | 5 | M1 | NO | 41 | | | | | Motor 14,0 mm shaft. 1 pcs M12 connectors. 80V driver |
| MIS | 342 B | | 5 | M7 | NO | 76 | | | | | Motor 14,0 mm shaft. 4 pcs M12 connectors. 80V controller. DeviceNet. Encoder H2 option |
| # : End of number. No more letters or numbers should be added. | | | | | | | | | | | |

Mechanical dimensions

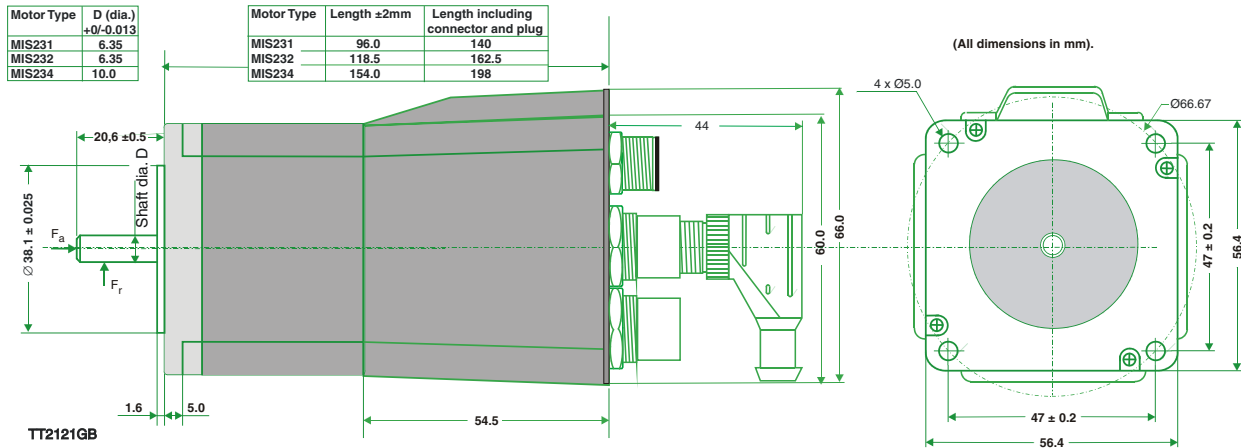

Planetary and cycloidal gearheads

- Sealed Ball Bearings
- High Reliability, High Efficiency Design
- NEMA Mounting Standards
- High Shaft Loading Capacity
- Low Backlash Design
- Strong, Caged Roller Bearings
- Precision Input Pinion with Balanced Clamp Collar

| Model | Backlash [arc min] | Gear ratio | Efficiency [%] | Rated torque >10000 Hours [Nm] | Emerg stop Torque [Nm] | Inertia at motor shaft [kg*cm ²] | Noise [dB(A)] | Radial load @12mm [N] | Axial load [N] | Weight [kg] | L1 [mm] | D1 [mm] | D2 [mm] (h7) |
|---------------------|-----------------------|------------|-------------------|---|------------------------------|---|------------------|-----------------------------|-------------------|----------------|------------|------------|--------------------|
| HTRG05N003MHN23106J | 15 | 3 | 97 | 12 | 40 | 0.28 | <70 | 500 | 600 | 1.0 | 68 | 55 | 12 |
| HTRG05N005MHN23106J | 15 | 5 | 97 | 15 | 45 | 0.17 | <70 | 500 | 600 | 1.0 | 68 | 55 | 12 |
| HTRG05N012MHN23106J | 15 | 12 | 94 | 20 | 60 | 0.16 | <70 | 500 | 600 | 1.2 | 84.8 | 55 | 12 |
| HTRG05N020MHN23106J | 15 | 20 | 94 | 20 | 60 | 0.16 | <70 | 500 | 600 | 1.2 | 84.8 | 55 | 12 |
| HTRG05N100MHN23106J | 15 | 100 | 90 | 20 | 60 | 0.11 | <70 | 500 | 600 | 1.5 | 98.6 | 55 | 12 |
| HSPG60-35-SAA-N23 | <1 | 35 | >90 | 37 | 74 | 0.006 | - | 2600 | 3700 | 1.34 | 71.8 | 63 | 34 |
| HSPG80-97-SAA-N23 | <1 | 97 | >90 | 78 | 156 | 0.027 | - | 4800 | 6900 | 2.10 | 78.8 | 80 | 46 |

L1: Gear length incl. flange, D2: Gear housing diameter, D2: Output shaft diameter

HTRG type gears:

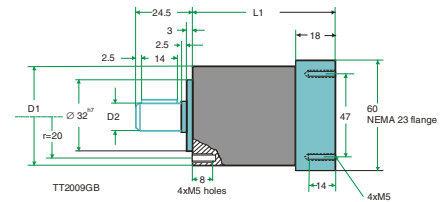

HSPG type gears:

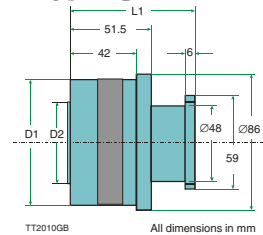

Get started quickly!

Starter Kit (MIS231A1M5N075KIT):
Contains all necessary parts to get started

The kit consists of:
 Motor, Power Supply, Software, Cables etc.
 PA0160 - Test box with (I/O and encoder emulation).
 WI0036 - Cable between test box and QuickStep motor.
 MIS231A1M5N075 - Integrated step motor.
 RS485-M12-1-5-5 - cable between QuickStep motor and USB converter.
 RS485-USB-ATC-820 USB to RS485 adaptor.
 PSU024-060-M12 - 24 VDC Power supply. 60W.
 MacTalk - Windows software for setup and programming.



JVL Industri Elektronik A/S
 Blokken 42
 DK-3460 Birkerød, Denmark
 Tel: +45 4582 4440
 Fax: +45 4582 5550
 E-mail: jvl@jvl.dk www.jvl.dk