

# SIEMENS

## SINAMICS

### SINAMICS G120 CU250S-2 Control Units

Compact Operating Instructions

<u>Fundamental safety instructions</u>	<b>1</b>
<u>Scope of delivery</u>	<b>2</b>
<u>Installing</u>	<b>3</b>
<u>Commissioning</u>	<b>4</b>
<u>More information</u>	<b>5</b>





Scan the QR code for additional information on SINAMICS G120.



## Legal information

### Warning notice system

This manual contains notices you have to observe in order to ensure your personal safety, as well as to prevent damage to property. The notices referring to your personal safety are highlighted in the manual by a safety alert symbol, notices referring only to property damage have no safety alert symbol. These notices shown below are graded according to the degree of danger.

 <b>DANGER</b>
indicates that death or severe personal injury <b>will</b> result if proper precautions are not taken.
 <b>WARNING</b>
indicates that death or severe personal injury <b>may</b> result if proper precautions are not taken.
 <b>CAUTION</b>
indicates that minor personal injury can result if proper precautions are not taken.
<b>NOTICE</b>
indicates that property damage can result if proper precautions are not taken.

If more than one degree of danger is present, the warning notice representing the highest degree of danger will be used. A notice warning of injury to persons with a safety alert symbol may also include a warning relating to property damage.

### Qualified Personnel

The product/system described in this documentation may be operated only by **personnel qualified** for the specific task in accordance with the relevant documentation, in particular its warning notices and safety instructions. Qualified personnel are those who, based on their training and experience, are capable of identifying risks and avoiding potential hazards when working with these products/systems.

### Proper use of Siemens products

Note the following:

 <b>WARNING</b>
Siemens products may only be used for the applications described in the catalog and in the relevant technical documentation. If products and components from other manufacturers are used, these must be recommended or approved by Siemens. Proper transport, storage, installation, assembly, commissioning, operation and maintenance are required to ensure that the products operate safely and without any problems. The permissible ambient conditions must be complied with. The information in the relevant documentation must be observed.

### Trademarks

All names identified by ® are registered trademarks of Siemens AG. The remaining trademarks in this publication may be trademarks whose use by third parties for their own purposes could violate the rights of the owner.

### Disclaimer of Liability

We have reviewed the contents of this publication to ensure consistency with the hardware and software described. Since variance cannot be precluded entirely, we cannot guarantee full consistency. However, the information in this publication is reviewed regularly and any necessary corrections are included in subsequent editions.

# Table of contents

<b>1</b>	<b>Fundamental safety instructions</b> .....	<b>4</b>
1.1	General safety instructions .....	4
1.2	Industrial security .....	5
<b>2</b>	<b>Scope of delivery</b> .....	<b>6</b>
<b>3</b>	<b>Installing</b> .....	<b>7</b>
3.1	Snapping the Control Unit onto the Power Module.....	7
3.2	Overview of the interfaces .....	8
3.3	Terminal blocks .....	10
3.4	Operator panels .....	14
<b>4</b>	<b>Commissioning</b> .....	<b>15</b>
4.1	Commissioning with STARTER .....	15
4.2	Connecting the inverter to the fieldbus .....	20
4.3	Frequently required parameters.....	22
<b>5</b>	<b>More information</b> .....	<b>25</b>
5.1	Manuals for your inverter .....	25
5.2	Product support.....	26

This manual describes how you install a SINAMICS G120 converter with CU250S-2 Control Unit and commission it.

## What is the meaning of the symbols in the manual?



An operating instruction starts here.





This concludes the operating instruction.

# 1

## Fundamental safety instructions

### 1.1 General safety instructions

 <b>WARNING</b>
<b>Risk of death if the safety instructions and remaining risks are not carefully observed</b>
If the safety instructions and residual risks are not observed in the associated hardware documentation, accidents involving severe injuries or death can occur.
<ul style="list-style-type: none"><li>• Observe the safety instructions given in the hardware documentation.</li><li>• Consider the residual risks for the risk evaluation.</li></ul>

 <b>WARNING</b>
<b>Danger to life or malfunctions of the machine as a result of incorrect or changed parameterization</b>
As a result of incorrect or changed parameterization, machines can malfunction, which in turn can lead to injuries or death.
<ul style="list-style-type: none"><li>• Protect the parameterization (parameter assignments) against unauthorized access.</li><li>• Respond to possible malfunctions by applying suitable measures (e.g. EMERGENCY STOP or EMERGENCY OFF).</li></ul>

## 1.2 Industrial security

### Note

#### Industrial security

Siemens provides products and solutions with industrial security functions that support the secure operation of plants, solutions, machines, equipment and/or networks. They are important components in a holistic industrial security concept. With this in mind, Siemens' products and solutions undergo continuous development. Siemens recommends strongly that you regularly check for product updates.

For the secure operation of Siemens products and solutions, it is necessary to take suitable preventive action (e.g. cell protection concept) and integrate each component into a holistic, state-of-the-art industrial security concept. Third-party products that may be in use should also be considered. For more information about industrial security, visit Hotspot-Text (<http://www.siemens.com/industrialsecurity>).

To stay informed about product updates as they occur, sign up for a product-specific newsletter. For more information, visit Hotspot-Text (<http://support.automation.siemens.com>).

#### WARNING

##### **Danger as a result of unsafe operating states resulting from software manipulation**

Software manipulation (e.g. by viruses, Trojan horses, malware, worms) can cause unsafe operating states to develop in your installation which can result in death, severe injuries and/or material damage.

- Keep the software up to date.  
You will find relevant information and newsletters at this address (<http://support.automation.siemens.com>).
- Incorporate the automation and drive components into a holistic, state-of-the-art industrial security concept for the installation or machine.  
You will find further information at this address (<http://www.siemens.com/industrialsecurity>).
- Make sure that you include all installed products into the holistic industrial security concept.

# 2

## Scope of delivery

### Scope of delivery

The delivery comprises at least the following components:

- A CU250S-2 Control Unit ready for operation with installed firmware.

Options for upgrading and downgrading the firmware can be found on the Internet:

Firmware (<http://support.automation.siemens.com/WW/news/en/67364620>).

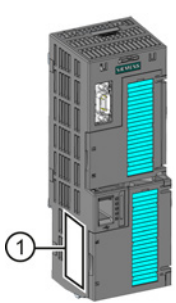
	The fieldbus interface of the Control Unit depends on the order number. The order number, the designation and the version of the hardware (e.g. 02) and firmware (e.g. 4.6) can be found on the rating plate ① of the Control Unit.		
	Designation	Order number	Fieldbus
	CU250S-2	6SL3246-0BA22-1BA0	USS, Modbus RTU
	CU250S-2 DP	6SL3246-0BA22-1PA0	PROFIBUS
	CU250S-2 PN	6SL3246-0BA22-1FA0	PROFINET, EtherNet/IP
CU250S-2 CAN	6SL3246-0BA22-1CA0	CANopen	

- Compact Operating Instructions in German and English
- The inverter contains open-source software (OSS). The OSS license terms are saved in the inverter.

### Transferring license terms of the OSS code to a PC

#### Procedure



To transfer the OSS license terms from the inverter to a PC, proceed as follows:

1. Switch off the inverter power supply.
2. Insert an empty memory card into the card slot of the inverter. Also see Section: Overview of the interfaces (Page 8)
3. Switch on the inverter power supply.
4. When you have switched on the power supply, wait 30 seconds.  
During this time, the inverter writes the "Read\_OSS.ZIP" file onto the memory card.
5. Switch off the inverter power supply.
6. Remove the card from the inverter.
7. Use a card reader and load the file to a PC.



You have then transferred the OSS license terms from the inverter to a PC.

# Installing

## 3.1 Snapping the Control Unit onto the Power Module

### Installing the Control Unit on an IP20 Power Module



#### Procedure

Proceed as follows to connect Power Modules and Control Units:

1. Locate the lugs at the rear of the Control Unit in the matching recesses of the Power Module.
2. Mount the Control Unit onto the Power Module so that it audibly snaps into place.

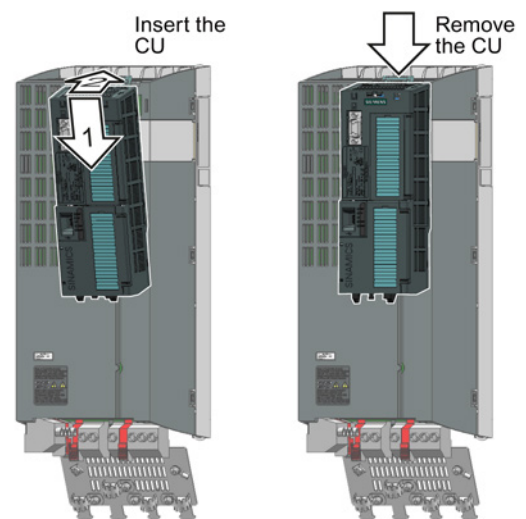

The Power Module and the Control Unit are now connected with one another.

To remove the Control Unit, press on the release button on the Power Module and withdraw the Control Unit.

### Permissible Power Modules

You may operate the Control Unit with the following Power Modules:

- PM240
- PM240-2
- PM250
- PM260
- PM340 1AC

### 3.2 Overview of the interfaces

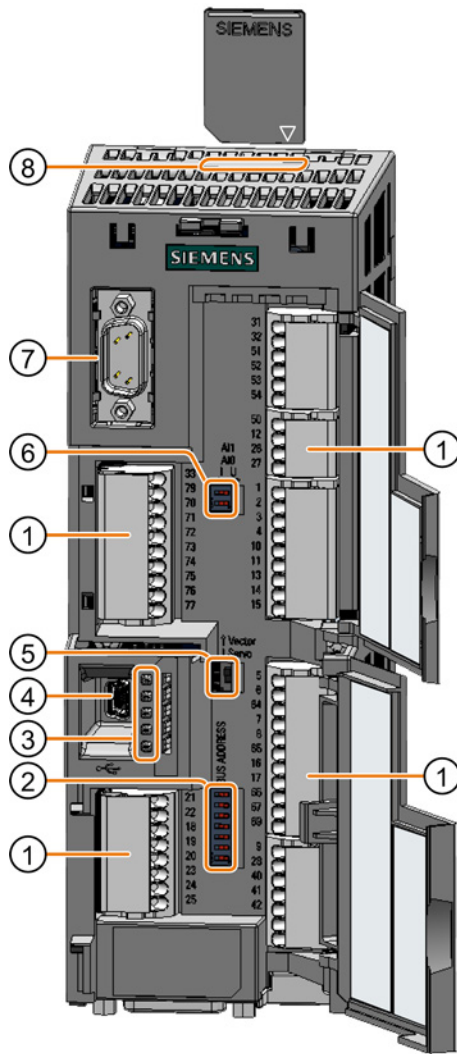

To access the interfaces at the front of the Control Unit, you must unplug the Operator Panel (if one is being used) and open the front doors.

- ① Terminal strips
- ② Fieldbus interface
  - PROFIBUS
  - USS
  - Modbus RTU
  - CanOpen

Selecting the fieldbus address:

Bit 6 (64)	<input type="checkbox"/>
Bit 5 (32)	<input type="checkbox"/>
Bit 4 (16)	<input type="checkbox"/>
Bit 3 (8)	<input type="checkbox"/>
Bit 2 (4)	<input type="checkbox"/>
Bit 1 (2)	<input type="checkbox"/>
Bit 0 (1)	<input type="checkbox"/>
On	Off

- ③ Status LED

<input type="checkbox"/>	RDY
<input type="checkbox"/>	BF
<input type="checkbox"/>	SAFE
<input type="checkbox"/>	LNK1, only for PROFINET
<input type="checkbox"/>	LNK2, only for PROFINET

- ④ USB interface for connection to a PC
- ⑤ No function. Keep the switch in the "Vector" position.

- ⑥ Switch for analog inputs
- I 0/4 mA ... 20 mA
- U -10/0 V ... 10 V

AI 1	<input type="checkbox"/>
AI 0	<input type="checkbox"/>
I U	

- ⑦ Connection to the operator panel
- ⑧ Memory card slot

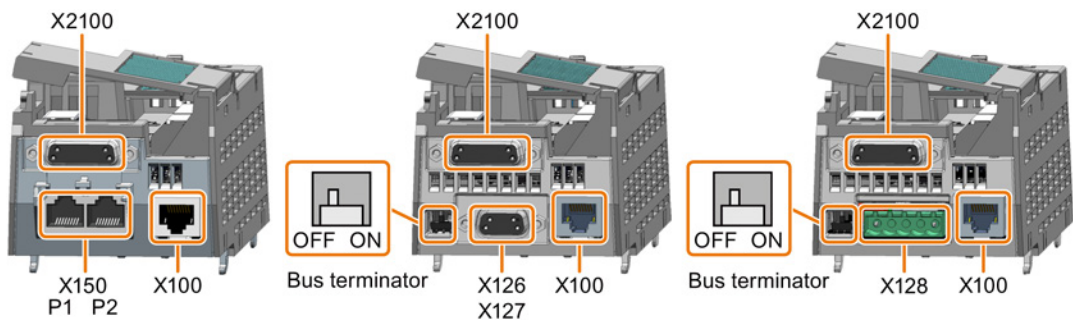



Interfaces at the lower side of the Control Unit



**X150 P1**  
**X150 P2**  
**PROFINET**

8 ... 1

- 1 RX+ Receive data +
- 2 RX- Receive data -
- 3 TX+ Transmit data +
- 4 ---
- 5 ---
- 6 TX- Transmit data -
- 7 ---
- 8 ---

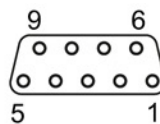

**X126**  
**CAN**

9 6  
5 1

- 1 ---
- 2 CAN\_L, CAN signal (dominant low)
- 3 CAN\_GND, CAN ground
- 4 ---
- 5 (CAN\_SHLD), optional shield
- 6 (GND), optional ground
- 7 CAN\_H, CAN signal (dominant high)
- 8 ---
- 9 ---

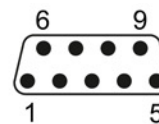

**X127**  
**PROFIBUS**

6 9  
1 5

- 1 ---
- 2 M, reference potential for P24\_Serv
- 3 RxD/TxD-P, receive and transmit (B/B')
- 4 CNTR-P, control signal
- 5 GND, reference potential for data (C/C')
- 6 + 5 V power supply
- 7 P24\_Serv
- 8 RxD/TxD-N, receive and transmit (A/A')
- 9 ---

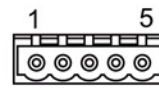

**X128**  
**RS485**

1 5

- 1 0 V, reference potential
- 2 RS485P, receive and transmit (+)
- 3 RS485N, receive and transmit (-)
- 4 Cable shield
- 5 ---

  

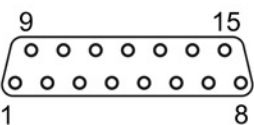

**X2100**  
**Encoder**

9 15  
1 8

	KTY84, PTC or bimetal	HTL	TTL	SSI (RS422 standard)
1 Motor temperature sensing +	Temp +	---	---	---
2 SSI clock	---	---	---	Clock +
3 Inverse SSI clock	---	---	---	Clock -
4 5 V / 24 V encoder supply	---	P-Encoder	P-Encoder	P-Encoder
5 5 V / 24 V encoder supply	---	P-Encoder	P-Encoder	P-Encoder
6 Sense input, encoder supply	---	---	P-Sense	---
7 0 V, reference for encoder supply	---	M-Encoder	M-Encoder	M-Encoder
8 Motor temperature sensing -	Temp -	---	---	---
9 0 V, reference for sense input	---	---	M-Sense	---
10 Referencing signal	---	R +	R +	---
11 Inverse referencing signal	---	R -	R -	---
12 Inverse incremental signal B	---	B -	B -	---
13 Incremental signal B	---	B +	B +	---
14 Inverse incremental signal A/SSI data	---	A -	A -	Data -
15 Incremental signal A/SSI data	---	A +	A +	Data +



**X100**  
**DRIVE-CLiQ**  
**Encoder**

1 ... 8  
A B

Encoder with DRIVE-CLiQ interface or encoder via Sensor Module

- 1 Transmit data +
- 2 Transmit data -
- 3 Receive data +
- 4 ---
- 5 ---
- 6 Receive data -
- 7 ---
- 8 ---
- A + 24 V power supply
- B M, reference for power supply

Table 3- 1 Permissible encoders on the DRIVE-CLiQ interface X100

	DRIVE-CLiQ encoder	Resolver	HTL encoder	TTL encoder	SSI encoder	Endat 2.1	sin/cos encoder
Direct connection	✓	---	---	---	---	---	---
Connection via Sensor Module SMC10, SMC20, SMC30, SME20 or SME25	---	✓	✓	✓	✓	✓	✓

The permissible combinations of encoders for speed control and position control are listed in the "Basic Positioner" Function Manual, see also: Manuals for the Control Unit (<http://support.automation.siemens.com/WW/view/en/30563628/133300>).

### 3.3 Terminal blocks

#### Terminal strips behind the upper front door

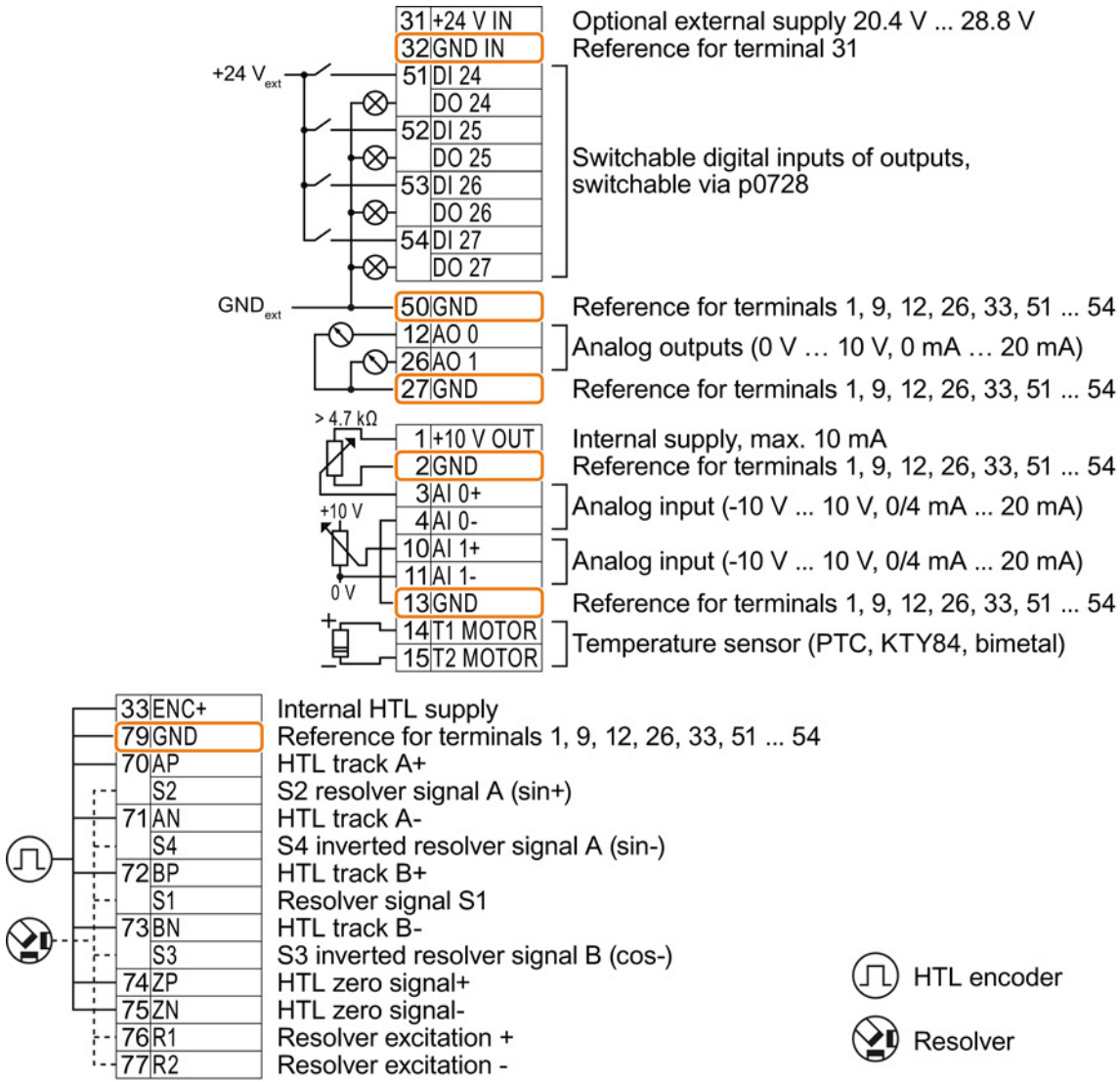

Different reference potentials:  
 The terminals labelled "GND" are connected internally.  
 "GND" and "GND IN" are not connected internally.

Figure 3-1 Interconnection example of the digital inputs with external 24 V power supply

#### Interconnecting the analog inputs (terminals 3, 4 and 10, 11)

For the analog inputs, you may use the internal 10 V supply (example: terminals 1 ... 4, 13) or an external supply (example: terminals 10, 11).

If you use the internal 10 V supply, you must connect AI 0- or AI 1- to GND.

### Optional 24 V supply (terminals 31, 32)

Connection of the optional 24 V supply has the following advantages:

- The Control Unit remains in operation after disconnection of the Power Module from the line supply. The Control Unit thus maintains the fieldbus communication, for example.
- You can use terminals 51 ... 54 as digital outputs.

Use a power supply that provides an output voltage in accordance with SELV (Safety Extra Low Voltage) or PELV (Protective Extra Low Voltage).



If you use a common external power supply for terminals 31, 32 and the digital inputs, you must connect GND to GND IN.

### Terminal strips behind the lower front door

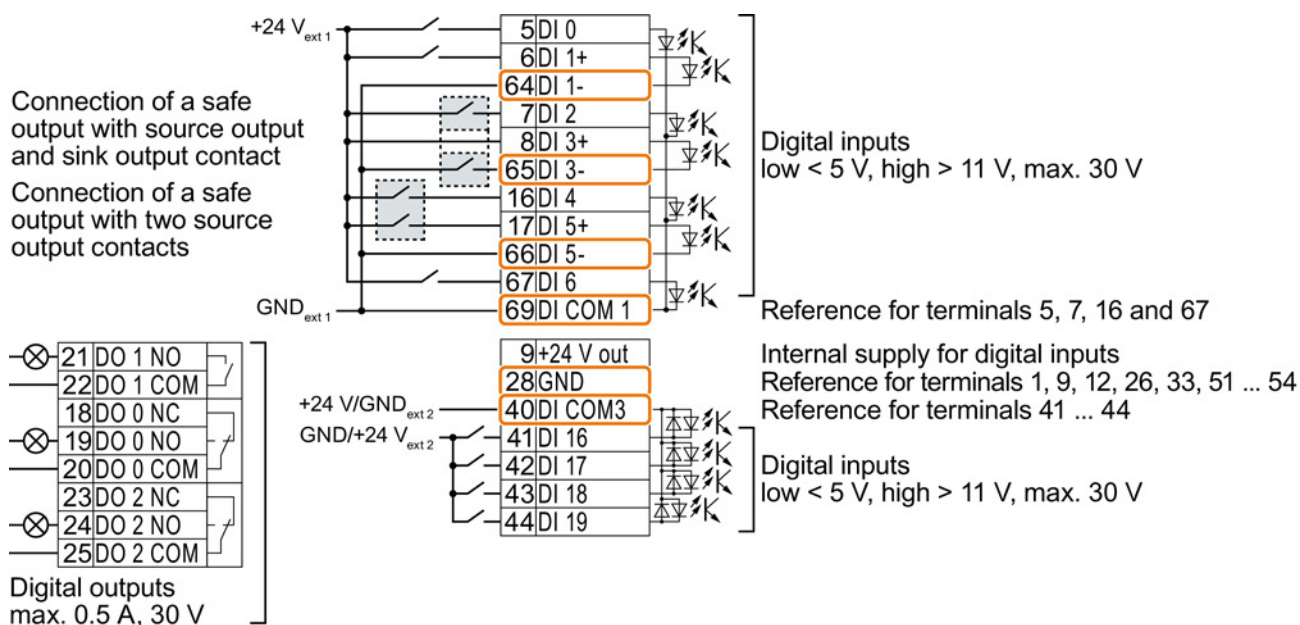

Different reference potentials:

The reference potentials of the digital inputs are not connected internally to each other or to GND.

Figure 3-2 Interconnection example of the digital inputs with external 24 V power supplies

### Interconnecting the reference potential of the digital inputs



Table 3-2 Supply options for the digital inputs

Supply	Reference potential interconnection
You are using an external 24 V supply	Connect the reference potential of the external 24 V supply to the reference potential of the appropriate digital input.
You are using the internal 24 V supply at terminal 9	Connect the appropriate reference potential of the digital input to GND.

**Factory setting of the terminal strips**

The factory setting of the terminals depends on the Control Unit.

**Control Units with USS or CANopen interface**

The fieldbus interface is not active.

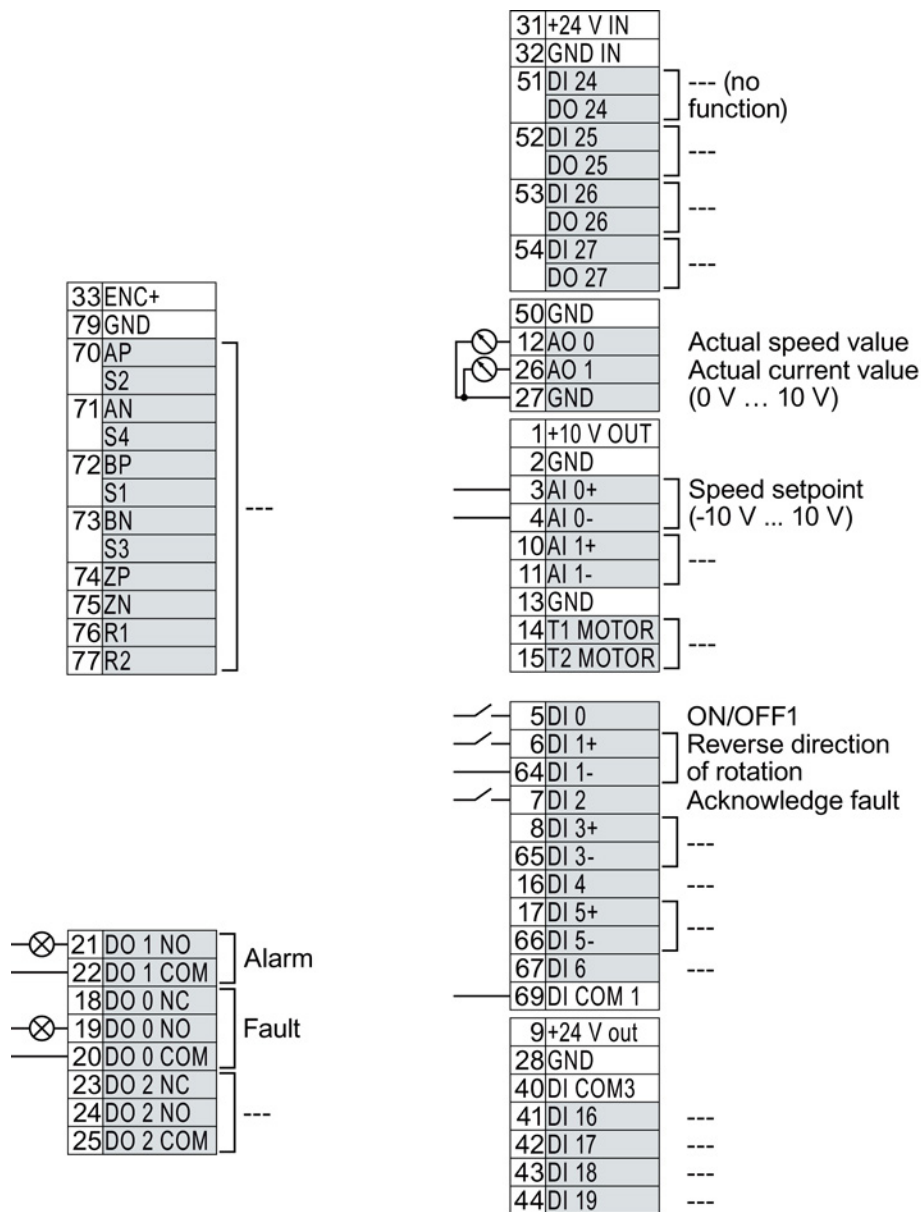

Figure 3-3 Factory setting of the CU250S-2 and CU250S-2 CAN Control Units

**Control Units with PROFIBUS or PROFINET interface**

The function of the fieldbus interface depends on DI 3.

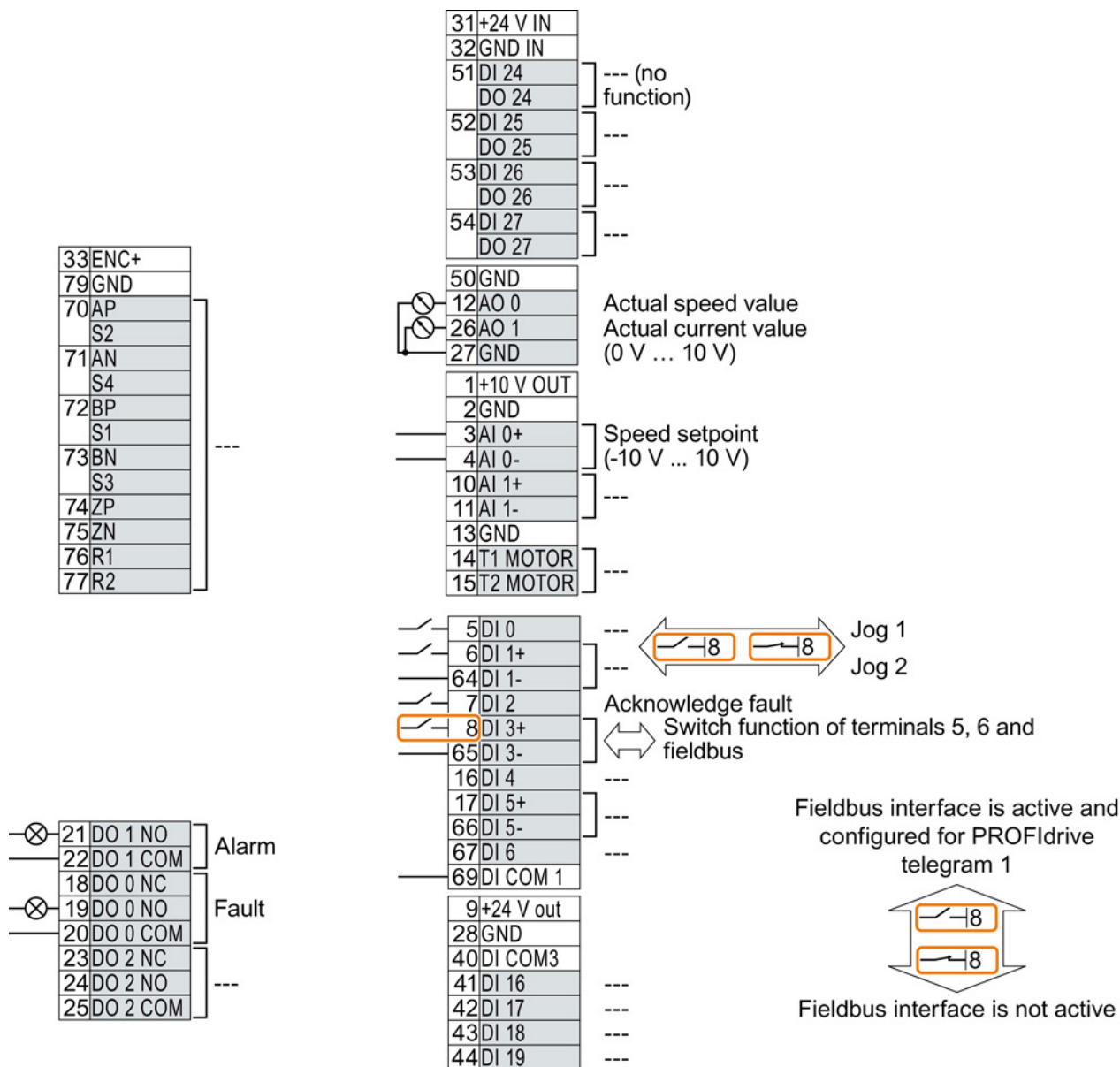

Figure 3-4 Factory setting of the CU250S-2 DP and CU250S-2 PN Control Units

### Changing the function of the terminals

The function of the terminals marked in color in the two figures above, can be set.

In order that you do not have to successively change terminal for terminal, several terminals can be jointly set using default settings ("p0015 Macro drive unit").

The factory settings of the terminals for USS/CANopen and PROFIBUS/PROFINET described above correspond to the following default settings:

- p0015 = 12 (setting in STARTER: "Standard I/O with analog setpoint")
- p0015 = 7 (setting in STARTER: "Fieldbus with data set switchover")

Further default settings can be found in the Operating Instructions, see also: Manuals for the Control Unit (<http://support.automation.siemens.com/WW/view/en/30563628/133300>).

### Wiring the terminal strip in compliance with EMC

1. If you use shielded cables, then you must connect the shield to the mounting plate of the control cabinet or with the shield support of the inverter through a good electrical connection and a large surface area.  
See also: EMC installation guideline (<http://support.automation.siemens.com/WW/view/en/60612658>)
2. Use the shield connection plate (order number 6SL3264-1EA00-0LA0) of the Control Unit as strain relief.

## 3.4 Operator panels



The Intelligent Operator Panel (IOP) is available for snapping on to the Control Unit or as handheld with a connection cable to the Control Unit. The graphics-capable plain text display of the IOP enables intuitive operation and diagnostics of the inverter.

See also: Compatibility of the IOP and Control Units (<http://support.automation.siemens.com/WW/view/en/67273266>)



The BOP-2 is an operator panel for snapping on to the Control Unit. The BOP-2 has a two-line display for operation and diagnostics of the inverter.

Further information can be found in the Operating Instructions of the BOP-2 and the IOP: Operator Panels (<http://support.automation.siemens.com/WW/view/en/30563514/133300>).

# Commissioning

## Requirements for commissioning

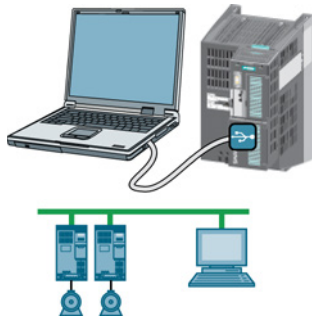

Use one of the PC tools STARTER or Startdrive to commission the inverter.

You can access the inverter with STARTER or Startdrive either via a USB connection or via the fieldbus.

System requirements and download:

- STARTER (<http://support.automation.siemens.com/WW/view/en/26233208>)
- Startdrive (<http://support.automation.siemens.com/WW/view/en/88851265>)

Help for the operation and for the functions of the commissioning tools:

- STARTER videos (<http://www.automation.siemens.com/mcms/mc-drives/en/low-voltage-inverter/sinamics-g120/videos/Pages/videos.aspx>)
- Startdrive tutorial (<http://support.automation.siemens.com/WW/view/en/73598459>)

Commissioning with STARTER is described in the following.

## 4.1 Commissioning with STARTER

### Creating a STARTER project

#### Procedure



1  
2

In order to create a new project, proceed as follows:

1. In the STARTER menu, select "Project" → "New...".
2. Specify a name of your choice for the project.



You have created a new STARTER project.

### Transferring inverters connected via USB to the project

#### Procedure



Proceed as follows to transfer an inverter connected via USB to your project:

1. Switch on the inverter power supply.
2. First insert a USB cable into your PC and then into the inverter.
3. The PC operating system installs the USB driver when you are connecting the inverter and PC together for the first time.
  - Windows 7 installs the driver automatically.
  - For Windows XP you must acknowledge several system messages.
4. Start the STARTER commissioning software.
5. In STARTER, press the  ("Accessible nodes") button.



6. When the USB interface is appropriately set, then the "Accessible nodes" screen form shows the inverters that can be accessed.

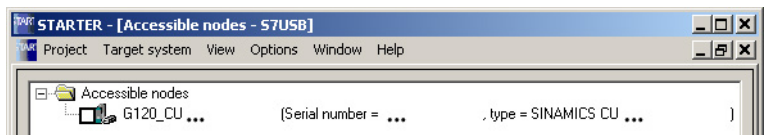

If you have not correctly set the USB interface, then the following "No additional nodes found" message is displayed. In this case, follow the description below.

7. Select the inverter .
8. Press the "Accept" button.



You have transferred an inverter accessible via the USB interface into your project.



## Setting the USB interface

### Procedure



Proceed as follows to set the USB interface in STARTER:

1. In this case set the "Access point" to "DEVICE (STARTER, Scout)" and the "PG/PC interface" to "S7USB".
2. Press the "Update" button.

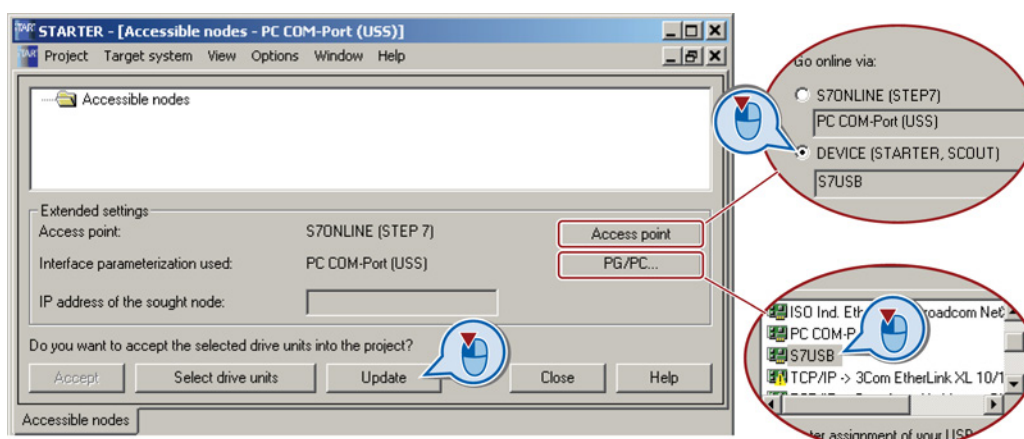

You have set the USB interface.

STARTER now shows the inverters connected via USB.

## Starting the configuration

### Procedure



To start the configuration, proceed as follows:

1. In STARTER select the drive you wish to commission.
2. Start the wizard for the device configuration:

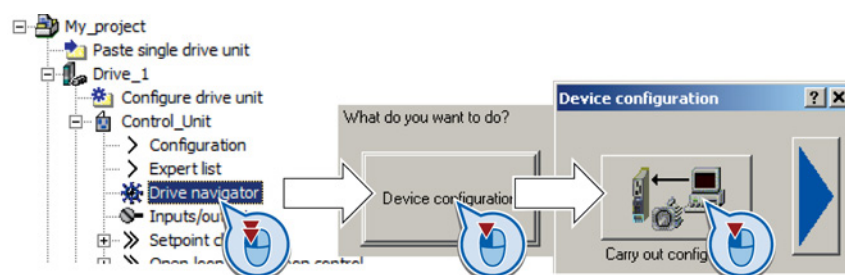

You have started the configuration.

**Performing the configuration**

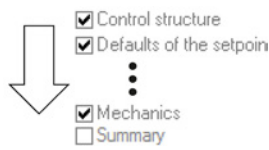

Follow the steps of the configuration wizard and enter the data of your application.

**Loading the configured data into the drive**

**Procedure**



Proceed as follows to load the configured data into the drive:

1. Select your project and go online: .
2. STARTER compares your configuration with the real inverter. STARTER signals any differences in the "Online/offline comparison".  
Acknowledge the message by pressing the "Load HW configuration to PG" button.
3. Open "Drive Navigator".
4. Select the "Commissioning" button.
5. Click on "Load data to the drive".

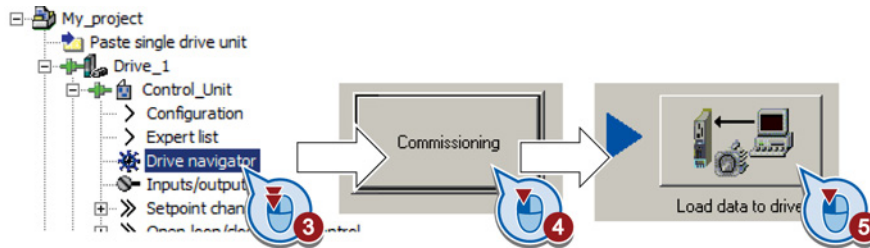

6.  In the screen form, select "After loading copy RAM to ROM".
7. Load your configuration into the inverter.
8. Close the "Commissioning" screen form.



You have loaded your configuration into the drive and therefore performed the basic commissioning.

**Identifying motor data**

**Requirements**

- In the basic commissioning, you have selected the motor identification (MOT ID). In this case, after the basic commissioning has been completed, the inverter issues the alarm A07991.
- The motor has cooled down to the ambient temperature.

If the motor is too hot, the motor data identification will provide incorrect values and the vector control will become unstable.

 **DANGER**
**Risk of injury or material damage as a result of machine movements when switching on the motor**

Switching on the motor for identification purposes may result in hazardous machine movements.

Secure dangerous machine parts before starting motor data identification:

- Before switching on, check that no parts are loose on the machine or can be spun out.
- Before switching on, ensure that nobody is working on the machine or located within its working area.
- Secure the machine's work area against unintended access.
- Lower hanging/suspended loads to the floor.

**Procedure**



To initiate motor data identification and optimization of the motor control, proceed as follows:

1. Open by double-clicking on the control panel in STARTER.
2. Assume master control for the inverter.
3. Set the "Enable signals"
4. Switch on the motor.

The inverter starts the motor data identification.

This measurement can take several minutes.

After the measurement, the inverter switches off the motor.

5. Relinquish the master control after the motor data identification.
6. Click the  Save (RAM to ROM) button.

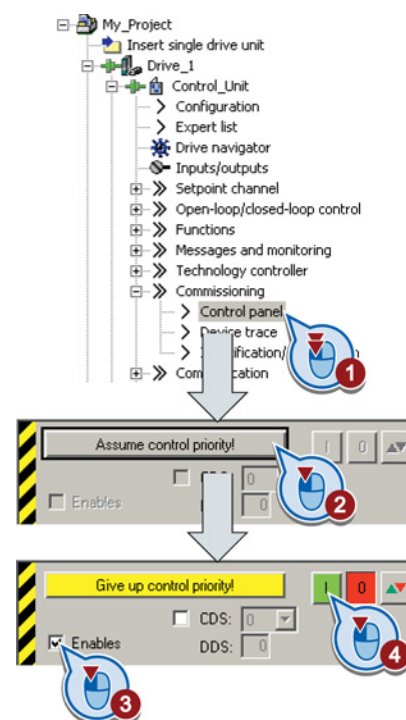

You have now completed motor data identification.

**Self-optimization of the closed-loop control**

If you have also selected a rotating measurement with self-optimization of the vector control in addition to the motor data identification, then you must switch on the motor again as described above and wait for the optimization run to be completed.

## 4.2 Connecting the inverter to the fieldbus

### Where can I find instructions for the fieldbus connection of the inverter?

You can find instructions for the fieldbus connection on the Internet:

- Application examples (<http://support.automation.siemens.com/WW/view/en/60733299>)
- Operating Instructions, "Inverter with CU250S-2 Control Units": Manuals for the Control Unit (<http://support.automation.siemens.com/WW/view/en/30563628/133300>)
- Function Manual, "Fieldbusses": Manuals for the Control Unit (<http://support.automation.siemens.com/WW/view/en/30563628/133300>)

### Example telegram

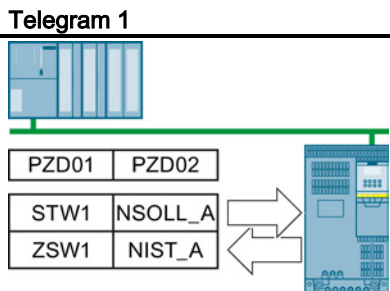
Telegram 1	Abbreviation	Explanation
	STW1	Control word 1
	ZSW1	Status word 1
	PZD01/02	Process data 16-bit
	NSOLL_A	Speed setpoint 16-bit
	NIST_A	Actual speed value 16-bit

The inverter telegrams without configured basic positioner are described in the Operating Instructions and in the "Communications" Function Manual: Manuals for the Control Unit (<http://support.automation.siemens.com/WW/view/en/30563628/133300>)

The telegrams with configured basic positioner are described in the "Basic Positioner and Technology" Function Manual: Manuals for the Control Unit (<http://support.automation.siemens.com/WW/view/en/30563628/133300>).

### Control word 1 (STW1)

Bit	Meaning	Explanation
0	0 = OFF1	The motor brakes with the ramp-down time p1121 of the ramp-function generator. The inverter switches off the motor at standstill.
	0 → 1 = ON	The inverter goes into the "ready" state. If, in addition bit 3 = 1, then the inverter switches on the motor.
1	0 = OFF2	Switch off the motor immediately, the motor then coasts down to a standstill.
	1 = No OFF2	The motor can be switched on (ON command).
2	0 = Quick stop (OFF3)	Quick stop: The motor brakes with the OFF3 ramp-down time p1135 down to standstill.
	1 = No quick stop (OFF3)	The motor can be switched on (ON command).
3	0 = Inhibit operation	Switch off the motor immediately, the motor then coasts down to a standstill.
	1 = Enable operation	The motor can be switched on (ON command).
4	0 = Disable RFG	The inverter immediately sets its ramp-function generator output to 0.
	1 = Do not disable RFG	The ramp-function generator can be enabled.

Bit	Meaning	Explanation
5	0 = Stop RFG	The output of the ramp-function generator stops at the actual value.
	1 = Enable RFG	The output of the ramp-function generator follows the setpoint.
6	0 = Inhibit setpoint	The inverter brakes the motor with the ramp-down time p1121 of the ramp-function generator.
	1 = Enable setpoint	Motor accelerates with the ramp-up time p1120 to the setpoint.
7	0 → 1 = Acknowledge faults	Acknowledge fault. If the ON command is still active, the inverter switches to "closing lockout" state.
8, 9	Reserved	
10	0 = No control via PLC	The inverter ignores the process data from the fieldbus.
	1 = Control via PLC	Control via fieldbus, the inverter accepts the process data from the fieldbus.
11	1 = Direction reversal	Invert setpoint in the inverter.
12	Not used	
13	1 = MOP up	Increase the setpoint saved in the motorized potentiometer.
14	1 = MOP down	Reduce the setpoint saved in the motorized potentiometer.
15	Reserved	
		Changes over between settings for different operation interfaces (command data sets).

### Status word 1 (ZSW1)

Bit	Meaning	Comments
0	1 = Ready to start	Power supply switched on; electronics initialized; pulses locked.
1	1 = Ready	Motor is switched on (ON/OFF1 = 1), no fault is active. With the command "Enable operation" (STW1.3), the inverter switches on the motor.
2	1 = Operation enabled	Motor follows setpoint. See control word 1, bit 3.
3	1 = Fault active	The inverter has a fault. Acknowledge fault using STW1.7.
4	1 = OFF2 inactive	Coast down to standstill is not active.
5	1 = OFF3 inactive	Quick stop is not active.
6	1 = Closing lockout active	It is only possible to switch on the motor after an OFF1 followed by ON.
7	1 = Alarm active	Motor remains switched on; no acknowledgement is necessary.
8	1 = Speed deviation within the tolerance range	Setpoint / actual value deviation within the tolerance range.
9	1 = Master control requested	The automation system is requested to accept the inverter control.
10	1 = Comparison speed reached or exceeded	Speed is greater than or equal to the corresponding maximum speed.
11	1 = torque limit reached	Comparison value for current or torque has been reached or exceeded.
12	1 = Holding brake open	Signal to open and close a motor holding brake.
13	0 = Alarm, motor overtemperature	--
14	1 = Motor rotates clockwise	Internal inverter actual value > 0
	0 = Motor rotates counterclockwise	Internal inverter actual value < 0
15	0 = Alarm, inverter thermal overload	

4.3 Frequently required parameters

Description files for fieldbuses

The description files are electronic device data sheets which contain all the required information of a higher-level controller. You can configure and operate the inverter on a fieldbus with the appropriate description file.

Description file	Download	Alternative to download
Generic Station Description (GSD) for PROFIBUS	Internet: ( <a href="http://support.automation.siemens.com/WW/view/en/23450835">http://support.automation.siemens.com/WW/view/en/23450835</a> )	GSD and GSDML are saved in the inverter. The inverter writes its GSD or GSDML to the memory card once you insert this card in the inverter and set p0804 to 12. You can then transfer the file to your programming device or PC using the memory card.
GSD Markup Language (GSDML) for PROFINET	Internet: ( <a href="http://support.automation.siemens.com/WW/view/en/26641490">http://support.automation.siemens.com/WW/view/en/26641490</a> )	
Electronic Data Sheet (EDS) for CANopen	Internet: ( <a href="http://support.automation.siemens.com/WW/view/en/48351511">http://support.automation.siemens.com/WW/view/en/48351511</a> )	---
EDS for Ethernet/IP	---	Further information can be found in the operating instructions

4.3 Frequently required parameters

Parameter	Explanation		
p0015	Macro drive unit Set defaults for inputs and outputs via a macro Terminal blocks (Page 10).		
r0018	Control Unit firmware version		
p0100	IEC/NEMA mot stds	0: Europe 50 [Hz] 1: NEMA motor (60 Hz, US units) 2: NEMA motor (60 Hz, SI units)	
p0304	Rated motor voltage [V]		
p0305	Rated motor current [A]		
p0307	Rated motor power [kW] or [hp]		
p0310	Rated motor frequency [Hz]		
p0311	Rated motor speed [rpm]		
p0601	Motor temperature sensor type		
	Terminal 14	T1 motor (+)	0: No sensor (factory setting) 1: PTC (→ p0604) 2: KTY84 (→ P0604) 4: Bimetal
	Terminal 15	T2 motor (-)	
p0625	Motor ambient temperature during commissioning [° C]		
p0640	Current limit [A]		

Parameter	Explanation			
r0722	<b>Digital inputs status</b>			
	.0	Terminal 5	DI 0	Selection of the possible settings: p0840 ON/OFF (OFF1) p0844 No coast-down (OFF2) p0848 No quick stop (OFF3) p0855 Unconditionally release holding brake p1020 Fixed speed setpoint selection Bit 0 p1021 Fixed speed setpoint selection Bit 1 p1022 Fixed speed setpoint selection Bit 2 p1023 Fixed speed setpoint selection Bit 3 p1035 Motorized potentiometer setpoint raise p1036 Motorized potentiometer lower setpoint p2103 Acknowledge faults p1055 Jog bit 0 p1056 Jog bit 1 p1110 Inhibit negative direction p1111 Inhibit positive direction p1113 Setpoint inversion p1122 Bypass ramp-function generator p1140 Enable ramp-function generator / inhibit ramp-function generator p1141 Continue ramp-function generator / freeze ramp-function generator p1142 Enable setpoint / inhibit setpoint p1230 DC braking activation p2103 Acknowledge faults p2106 External fault 1 p2112 External alarm 1 p2200 Technology controller enable
	.1	Terminal 6, 64	DI 1	
	.2	Terminal 7	DI 2	
	.3	Terminal 8, 65	DI 3	
	.4	Terminal 16	DI 4	
	.5	Terminal 17, 66	DI 5	
	.6	Terminal 67	DI 6	
	.11	Terminal 3, 4	AI 0	
	.12	Terminal 10, 11	AI 1	
	.16	Terminal 41	DI 16	
	.17	Terminal 42	DI 17	
	.18	Terminal 43	DI 18	
	.19	Terminal 44	DI 19	
	.24	Terminal 51	DI 24	
	.25	Terminal 52	DI 25	
	.26	Terminal 53	DI 26	
	.27	Terminal 54	DI 27	
p0730	<b>Signal source for terminal DO 0</b>		Terminals 19, 20 (NO contact) Terminals 18, 20 (NC contact)	Selection of the possible settings: 52.0 Ready for switching on 52.1 Ready for operation 52.2 Operation enabled 52.3 Fault present 52.4 Coast down active (OFF2) 52.5 Quick stop active (OFF3) 52.14 Motor rotates forwards 53.0 DC braking active 53.1 $n_{act} > p2167 (n_{off})$ 53.2 $n_{act} \leq p1080 (n_{min})$ 53.3 $l_{act} > p2170$ 53.4 $n_{act} > p2155$ 53.5 $n_{act} \leq p2155$ 53.6 $n_{act} \geq n_{set}$ 53.10 Technology controller output at the lower limit 53.11 Technology controller output at the upper limit
p0731	<b>Signal source for terminal DO 1</b>			
p0732	<b>Signal source for terminal DO 2</b>		Terminals 24, 25 (NO contact) Terminals 23, 25 (NC contact)	
p0755	<b>Analog inputs actual value [%]</b>			
	[0]	AI 0		
	[1]	AI 1		

4.3 Frequently required parameters

Parameter	Explanation	
p0756	<b>Analog input type</b>	
	[0]	Terminals 3, 4 AI 0
	[1]	Terminals 10, 11 AI 1
		0: Unipolar voltage input (0 V ...+10 V) 1: Unipolar voltage input monitored (+2 V... +10 V) 2: Unipolar current input (0 mA ...+20 mA) 3: Unipolar current input monitored (+4 mA ...+20 mA) 4: Bipolar voltage input (-10 V...+10 V)
p0771	<b>Analog outputs signal source</b>	
	[0]	Terminals 12, 13 AO 0
	[1]	Terminals 26, 27 AO 1
		Selection of the possible settings: 0: Analog output locked 21: Actual speed value 24: Output frequency smoothed 25: Output voltage smoothed 26: DC-link voltage smoothed 27: Actual current value (smoothed absolute value)
p0776[0, 1]	<b>Analog outputs, type</b>	
	[0]	Terminals 12, 13 AO 0
	[1]	Terminals 26, 27 AO 1
		0: Current output (0 mA ... +20 mA) 1: Voltage output (0 V ... +10 V) 2: Current output (+4 mA ... +20 mA)
p1001	<b>Fixed speed setpoint 1</b>	
p1002	<b>Fixed speed setpoint 2</b>	
p1003	<b>Fixed speed setpoint 3</b>	
p1004	<b>Fixed speed setpoint 4</b>	
p1058	<b>Jog 1 speed setpoint</b>	
p1059	<b>Jog 2 speed setpoint</b>	
p1070	<b>Main setpoint</b>	Selection of the possible settings: 0: Main setpoint = 0 755[0]: Value of analog input 0 1024: Fixed setpoint 1050: Motorized potentiometer 2050[1]: PZD 2 from the fieldbus
p1080	<b>Minimum speed [rpm]</b>	
p1082	<b>Maximum speed [rpm]</b>	
p1120	<b>Ramp-function generator ramp-up time [s]</b>	
p1121	<b>Ramp-function generator ramp-down time [s]</b>	
p1300	<b>Open-loop/closed-loop control operating mode</b>	Selection of the possible settings: 0: U/f control with linear characteristic 1: U/f control with linear characteristic and FCC 2: U/f control with parabolic characteristic 20: Speed control (without encoder) 21: Closed-loop speed control (with encoder) 22: Torque control (without encoder) 23: Torque control (with encoder)
p1310	<b>Starting (voltage boost) permanent</b>	
p1800	<b>Pulse frequency setpoint</b>	
p2030	<b>Fieldbus interface protocol selection</b>	Selection of the possible settings: 0: No protocol 3: PROFIBUS 7: PROFINET



## More information

### 5.1 Manuals for your inverter

#### Documentation on DVD

SINAMICS Manual Collection, order number 6SL3097-4CA00-0YG0

Table 5- 1 Manuals for your inverter for download

Information depth	Manual	Contents	Available languages	Download
++	<b>Compact Operating Instructions</b>	(This manual)	English, German, Italian, French, Spanish, Chinese	Manuals for the Control Unit ( <a href="http://support.automation.siemens.com/WW/view/en/30563628/133300">http://support.automation.siemens.com/WW/view/en/30563628/133300</a> )
+++	<b>Operating Instructions</b> for the SINAMICS G120 inverter with the CU250S-2 Control Units	Installing, commissioning and operating the inverter. Setting the inverter functions. Technical data.		
+++	<b>Function Manual, Basic Positioner</b>	Commissioning the basic positioner.		
+++	<b>Fieldbus Function Manual</b> for the SINAMICS G110M, G120, G120C and G120D inverters	Configuring fieldbusses.		
+++	<b>Function Manual for Safety Integrated</b> for the SINAMICS G110M, G120, G120C, G120D inverters and SIMATIC ET 200pro FC-2 converters	Configuring PROFIsafe. Installing, commissioning and operating fail-safe functions of the inverter.		
+++	<b>List Manual</b> for the CU250S-2 Control Unit	List of all parameters, alarms and faults of the inverter. Graphic function diagrams.		
+	<b>Getting Started</b> for the following SINAMICS G120 Power Modules: <ul style="list-style-type: none"> <li>• PM240, PM250 and PM260</li> <li>• PM240-2</li> </ul>	Installing the Power Module.	English	Manuals for the Power Modules ( <a href="http://support.automation.siemens.com/WW/view/en/30563173/133300">http://support.automation.siemens.com/WW/view/en/30563173/133300</a> )
+++	<b>Hardware Installation Manual</b> for the following SINAMICS G120 Power Modules: <ul style="list-style-type: none"> <li>• PM240</li> <li>• PM240-2</li> <li>• PM250</li> <li>• PM260</li> </ul>	Installing Power Modules, reactors and filters. Technical data Maintenance	English, German	

5.2 Product support

Information depth	Manual	Contents	Available languages	Download
+	<b>Installation Instructions</b> for reactors, filters and braking resistors	Installing components.	English	Manuals for the inverter accessories ( <a href="http://support.automation.siemens.com/WW/view/en/30563514/133300">http://support.automation.siemens.com/WW/view/en/30563514/133300</a> )
+++	<b>Operating Instructions</b> for the following Operator Panels: <ul style="list-style-type: none"> <li>• BOP-2</li> <li>• IOP</li> </ul>	Operating operator panels, installing door assembly kit for IOP.	English, German	
+++	<b>Configuration Manual</b> EMC installation guideline	EMC-compliant control cabinet design, potential equalization and cable routing	English, German, Italian, French, Spanish, Chinese	EMC installation guideline ( <a href="http://support.automation.siemens.com/WW/view/en/60612658">http://support.automation.siemens.com/WW/view/en/60612658</a> )
+++	<b>Manual</b> SINAMICS S110 Manual PM340 Power Module	Installing the PM340 Power Module. Technical data Maintenance	English, German, Italian, French, Spanish	S110 Manual ( <a href="http://support.automation.siemens.com/WW/view/en/49086218">http://support.automation.siemens.com/WW/view/en/49086218</a> )
+++	<b>SINAMICS S120 Control Units and Additional System Components</b>	Including: SMC and SME Sensor Modules	English, German, Italian, French, Spanish, Chinese, Russian	S120 system components ( <a href="http://support.automation.siemens.com/WW/view/en/68040800">http://support.automation.siemens.com/WW/view/en/68040800</a> )

## 5.2 Product support

Table 5- 2 Technical support

France	Germany	Italy	Spain	Great Britain
+33 (0) 821 801 122	+49 (0)911 895 7222	+39 (02) 24362000	+34 902 237 238	+44 161 446 5545
Other service telephone numbers: Product support ( <a href="http://www.siemens.com/automation/service&amp;support">http://www.siemens.com/automation/service&amp;support</a> )				