

SIEMENS

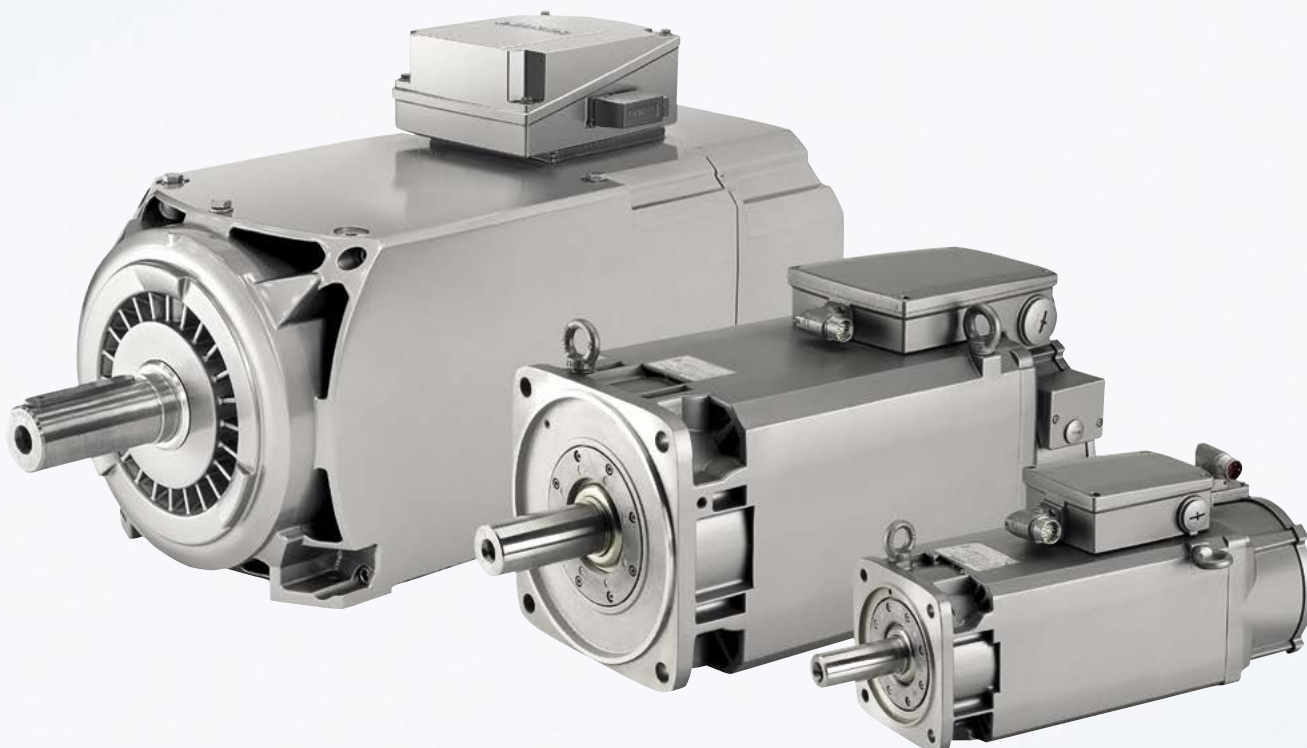

SIMOTICS M-1PH8 Main Motors

Dynamic power packs for main drives

Motors

Brochure

Edition
May
2016

siemens.com/main-motors

SIMOTICS Motors for Motion Control Tasks

The right motor for every motion control task







The right solution for any task

Synchronous or induction, with or without a gear unit. When you are looking for the optimum motor for your motion control application, Siemens is the right contact person for you. Our motor portfolio is the largest in the world! It includes servo and main motors, linear and torque motors as well as motor spindles – and all of them characterized by excellent dynamic performance and precision.

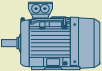
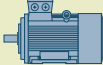
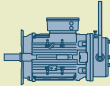
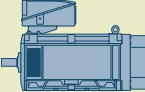
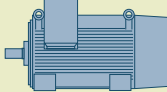
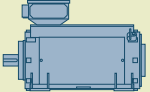
The demands on a SIMOTICS M-1PH8 main motor

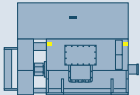
The wide range of motion control tasks in mechanical and plant engineering results in an equally wide range of requirement profiles for electrical drives. SIMOTICS M-1PH8 main motors have been specially developed for use in applications where continuous, precise rotation of the axes is a priority. They are capable of handling extreme duty cycles, short rise times and are exceptionally precise in terms of speed, torque, and positioning.

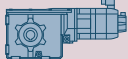
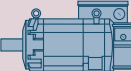
The motors embody a quality of dynamic response and drive performance which can meet the ever higher standards required from modern drive systems. With an extended power spectrum ranging from 2.8 to 1,340 kW, they can provide a solution for virtually any application.

SIMOTICS						
Low-voltage motors for line and converter operation						
General Purpose SIMOTICS GP	Severe Duty SIMOTICS SD	Explosion-proof SIMOTICS XP	Definite Purpose SIMOTICS DP	Flexible Duty SIMOTICS FD	Non standard SIMOTICS TN	High Torque SIMOTICS HT
						
DC motors		High-voltage motors				
Direct current SIMOTICS DC		High Voltage SIMOTICS HV				
						
Motors for motion control						
SIMOTICS S servomotors		SIMOTICS M main motors		SIMOTICS L linear motors		SIMOTICS T torque motors
Servomotors 	Servo geared motors 					

G_0011_EH_00491

Overview of the full SIMOTICS motor portfolio

SIMOTICS – the broadest motor portfolio worldwide. From low-voltage motors, through motors for motion control tasks, all the way to DC and high-voltage motors. With a wide range of performance categories and sizes, you are certain to find the right answer for your specific requirements.

SIMOTICS M-1PH8 Main Motors

The innovative modular system

The novel motor design

To develop the SIMOTICS M-1PH8 main motor series, a completely new modular concept was adopted in order to create higher-performance machines that are more flexible, energy efficient, and rugged.

The end result is the universal SIMOTICS M-1PH8 main motor series which already meets the requirements of the future and integrates seamlessly into a multitude of innovative machine concepts.

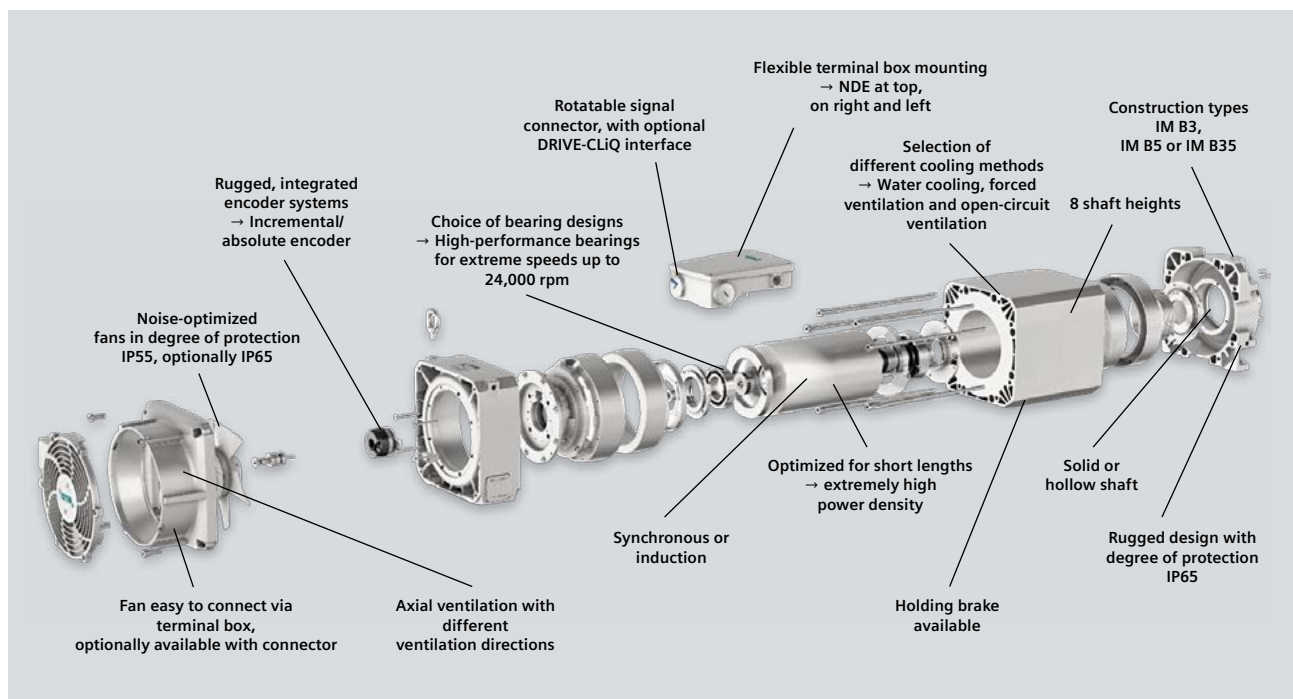

This QR code will take you directly to the SIMOTICS M-1PH8 main motors video!



SIMOTICS M-1PH8 Main Motors

The largest main motor portfolio in the world

Induction version of SIMOTICS M-1PH8 main motors: Performance meets cost efficiency

SIMOTICS M-1PH8 induction motors are the perfect choice for applications where exact rotation and precise controllability are a major priority. They are extremely cost efficient and deliver high power outputs while meeting the highest precision requirements. Thanks to its compatibility with the SINAMICS S or SINAMICS G drive systems, the SIMOTICS M-1PH8 induction motor has an even broader range of potential applications and can provide an impetus for the implementation of novel drive concepts.

Typical applications

- Machine tool spindles
- Paper and printing machines, winders
- Packaging machines
- Hoisting gear and crane systems
- Wood, glass, ceramics processing and stone working machines
- Test stands
- Presses
- Plastics processing machines
- Textile machines
- Wire-drawing machines

Synchronous version of SIMOTICS M-1PH8 main motors: The master of high torques

Synchronous models of SIMOTICS M-1PH8 main motors are the perfect solution for any application with high torque requirements. These compact, smooth-running power packs can be flexibly adapted to any application by a wide choice of options. They are available as forced-ventilated or water-cooled motors.

Typical applications

- Machine tools
- Servo presses and flying shears
- Printing machines
- Packaging machines
- Extruders, calenders, and rubber spray systems
- Foil machines, fleece machines, wire-drawing, and wire stranding machines
- Coiler and winder drives



The largest portfolio of main motors in the world, designed to meet the ever more exacting standards in modern mechanical and plant engineering, such as extreme duty cycles, short rise times and exceptionally high precision in terms of speed, torque, and positioning.

SIMOTICS M-1PH8 Main Motors

Flexible enough for any application

Customer benefits

Flexibility for any application is of primary importance for the SIMOTICS M-1PH8 main motors.

With their modular design principle, these motors can be configured for almost any drive solution. In applications requiring compact motors with a high dynamic response, for example, you can simply choose between induction or synchronous versions. If extreme ambient conditions or low noise levels are deciding factors, however, you can also choose between forced ventilation or water cooling. A multitude of options for electrically or mechanically integrating the motors into systems add to the all-round flexibility of the motors.

SIMOTICS M-1PH8 highlights

- The right solution for any application
 - Induction or synchronous versions
 - Forced ventilation, open-circuit ventilation, water cooling
 - Solid or hollow shaft
 - Different bearing concepts
 - Different encoder types for speed control and precision positioning
- Outstanding performance characteristics
 - Broad power range from 2.8 up to 1,340 kW
 - Maximum speeds up to 24,000 rpm
 - Minimal torque oscillations up to 10 μm
 - High vibrational quality (e.g. level B according to EN 60034-14)
 - High dynamic response (short startup times)
 - Very rugged
- Low noise emissions
- Winding switchover (star/delta) possible
- Simple, flexible connection system
- Commissioning with electronic rating plate and DRIVE-CLiQ interface
- Converter operation for the SINAMICS S and SINAMICS G drive systems

For you, this means:

Customer benefits	Features
Low capital costs	<ul style="list-style-type: none"> • A precisely customized motor (no oversizing) thanks to a large selection of different options and variants (8 shaft heights, 3 cooling methods, numerous windings and options) • Coordinated system components (e.g. cable and connection systems)
Increased productivity	<ul style="list-style-type: none"> • Outstanding performance (speed, rotational accuracy, vibrational quality) • Extremely high dynamic response (short startup times) • Winding switchover (star/delta) possible
Operational reliability and availability	<ul style="list-style-type: none"> • Very rugged • Separately driven fans for multi-range voltages • Increased electric strength • Insulation system in temperature class H (180° C) • Commissioning with electronic rating plate and DRIVE-CLiQ • Global support network and swift availability of spare parts • System-tested and optimally harmonized to operate with the SINAMICS drive system
Reduced operating costs	<ul style="list-style-type: none"> • Potential efficiency is extremely high, depending on selection of synchronous or induction version • Use of energy-efficient EC fans (in shaft heights 180 and 225) • Long maintenance intervals due to long bearing lifetime

SIMOTICS M-1PH8 Main Motors

The power pack with lots of appeal

Extended power spectrum

The SIMOTICS M-1PH8 main motor is available in a total of eight different shaft heights from 80 to 355 and with three different methods of cooling, i.e. water cooling, forced ventilation and open-circuit ventilation. With a wide choice of different winding designs, drives can be freely configured with power ratings ranging from 2.8 kW to 1,340 kW.

Extremely rugged

Degrees of protection up to IP65, bearings designed for a broad range of different requirements, a vibration-resistant design and state-of-the-art materials make the main drives from Siemens extremely rugged.

The encoder system is integrated in the motors, which means that it is fully protected against mechanical damage as well as the ingress of particles and moisture. Whether as an incremental encoder with HTL technology, a high-resolution, optical incremental and absolute encoder, or as a compact hollow-shaft encoder, the integrated encoder system can fulfill any requirement.

A range of standard options is available with which the SIMOTICS M-1PH8 main motors can be extended to cope with extreme application conditions. For example, shaft sealing rings can be used to seal mounted gear units or provide additional protection in oily environments. Mounted filter systems allow air-cooled versions to be used in environments with a high dust content.

Maximum flexibility

The SIMOTICS M-1PH8 main motors are multi-talented devices that can be freely configured thanks to their modular design principle. Depending on drive requirements, you can choose from a range of synchronous or induction motors which are identical in appearance and dimensions. A similarly wide range of cooling methods is also available, such as closed/open-circuit air cooling or water cooling. If exacting demands regarding the service life of the motor bearings have to be met, you can choose between standard bearings, bearings for elevated radial forces, "advanced lifetime" bearings, or bearings for higher speeds depending on the application.

In addition to the mechanical integration of the motors in the lower output range by means of solid or hollow shafts, the motors can be equipped with a wide range of different encoder systems. The motors can also be operated without encoders depending on the control type and task.

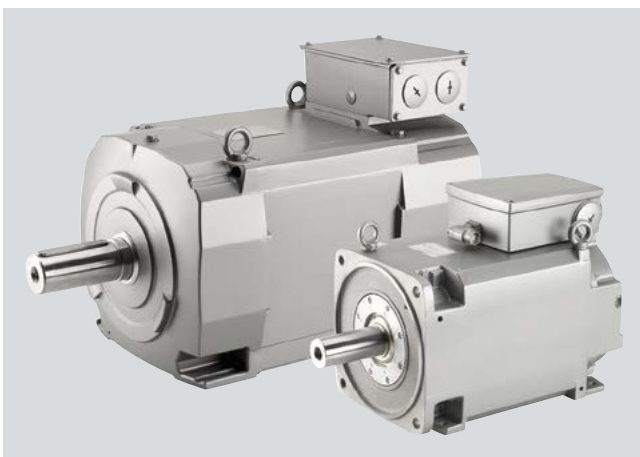

*SIMOTICS M-1PH8 motor with water cooling
(in the figure: Shaft heights 180 and 132)*

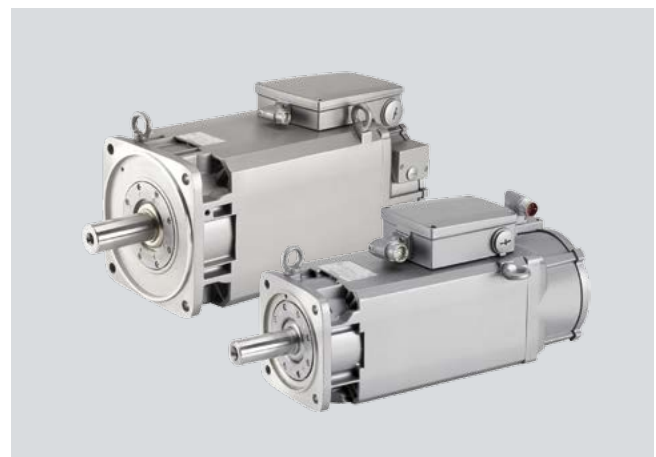

*SIMOTICS M-1PH8 motor with forced ventilation
(in the figure: Shaft heights 132 and 80)*

SIMOTICS M-1PH8 Main Motors

The power pack with lots of appeal

Outstanding performance

If the motors are to be used for high speeds, e.g. on machine tools or test stands, the motors of the SIMOTICS M-1PH8 series can be equipped with high-performance bearings for speeds of up to 24,000 rpm. Minimal torque oscillations (up to 10 μm) and excellent vibrational quality (e.g. level B according to EN 60034-14) further increase the drive quality in this extended speed setting range. Low motor moments of inertia combined with high overload capability also enhance the dynamic response in the process and increase the productivity of the machine or plant.

Easy to integrate

An adaptable connection system with terminal box or power connector makes it easy to integrate the motors into any application environment in the low output range. In the medium and upper output range, you can choose the position of the terminal box even in the most confined of spaces. You can carry out these and other mechanical adjustments easily and check your configuration using our dimension drawing generator CAD CREATOR*). An optimum scheme for mechanically adapting any SIMOTICS M-1PH8 main motor can therefore be generated online at the outset. 3D drawings generated by the tool can then be used straight away in the machine or plant design.

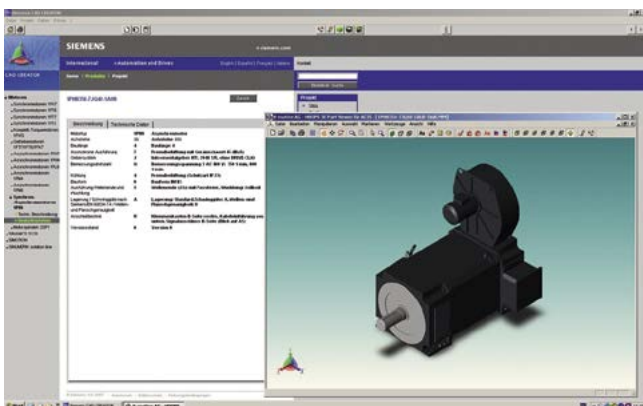

The CAD Creator tool provides a range of dimension drawings for the mechanical design

*) Access to selection and engineering tools:
www.siemens.com/cad-creator
www.siemens.com/sizer

System integration

The SIZER for Siemens Drives*) engineering software helps you dimension the main motor series and guides you through the process of selecting the required drive components. Starting from the type of application in question, the software provides a step-by-step guide to dimensioning your motor, resulting in a list of all the components along with the relevant order data. When developing the range of SIMOTICS M-1PH8 main drives, we took special care to ensure maximum compatibility with the SINAMICS S and SINAMICS G drive system. Specially harmonized power components, electronic rating plates, and the ability to integrate the motors via the DRIVE-CLiQ system interface with a SINAMICS S converter ensure quick and easy commissioning as well as smooth operation. Pre-assembled MOTION-CONNECT signal and power cables offer an easy, reliable method for connecting the components.

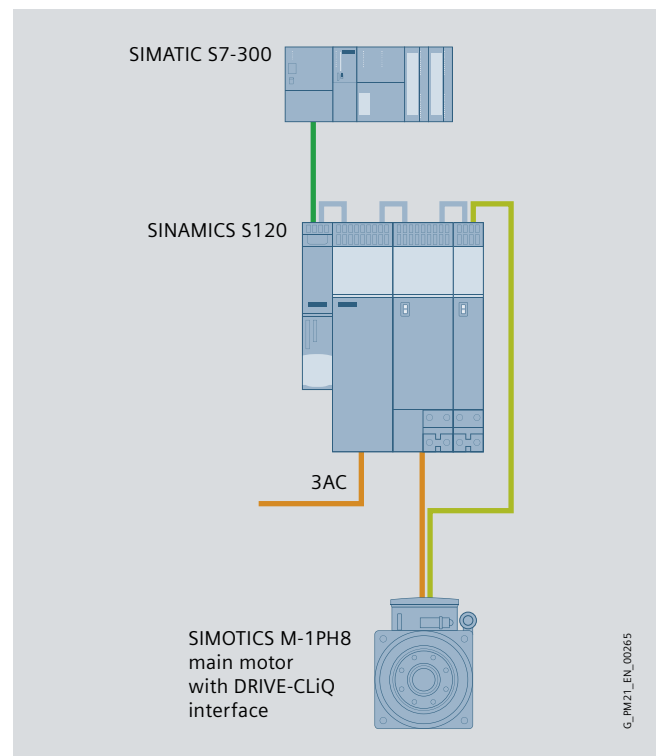

Integrating the SIMOTICS M-1PH8 main motor into the SINAMICS S120 drive system



SIMOTICS M-1PH8 Main Motors

Technical specifications

						
Motor type	1PH808...	1PH810...	1PH813...		1PH816...	
Cooling method	Water cooling, forced ventilation					
Motor principle	Induction		Induction	Synchronous	Induction	Synchronous
Shaft height	80	100	132		160	
Degree of protection	IP55 and IP65					
Construction type	IM B3 IM B5			IM B3 IM B5 IM B35		
Line voltage	400 ... 480 V					
Rated power	2.8 ... 9.5 kW	2.5 ... 21 kW	2.9 ... 37 kW	15.7 ... 76 kW	9.5 ... 83 kW	59 ... 125 kW
Rated speed	1,500 ... 12,000 rpm	400 ... 3,900 rpm	400 ... 3,600 rpm	1,500 ... 3,600 rpm	400 ... 2,800 rpm	1,500 ... 3,000 rpm
Rated torque	3 ... 29 Nm	23 ... 89 Nm	68 ... 191 Nm	94 ... 286 Nm	158 ... 333 Nm	285 ... 530 Nm
Max. speed	24,000 rpm	18,000 rpm	15,000 rpm	4,500 rpm	10,000 rpm	4,000 rpm
Max. torque	19 ... 67 Nm	60 ... 180 Nm	80 ... 400 Nm	220 ... 460 Nm	570 ... 730 Nm	915 ... 1,280 Nm
Connection system	Terminal box, signal connection via connector, or power connector				Terminal box, signal connection via connector	
Holding brake	Optional					
Insulation	Temperature class H (180 °C)					
Shaft design	Solid shaft with or without feather key, hollow shaft					
Encoder system	Incremental encoder HTL, sin/cos Absolute encoder EnDat Hollow-shaft encoder					
DRIVE-CLiQ interface	Optional					
Converter system	SINAMICS S or SINAMICS G					

SIMOTICS M-1PH8 Main Motors

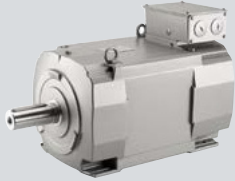
Technical specifications

						
Motor type	1PH818...		1PH822...		1PH828...	1PH835...
Cooling method	Water cooling, forced ventilation, open-circuit ventilation					Forced ventilation, open-circuit ventilation
Motor principle	Induction	Synchronous	Induction	Synchronous	Induction	
Shaft height	180		225		280	355
Degree of protection	IP23 and IP55					
Construction type	IM B3 IM B5 IM B35					IM B3 IM B35
Line voltage	400 ... 480 V				400 ... 690 V	
Rated power	17 ... 150 kW	33 ... 183 kW	30 ... 300 kW	48 ... 310 kW	63 ... 630 kW	160 ... 1,340 kW
Rated speed	400 ... 3,400 rpm	700 ... 3,200 rpm	400 ... 3,400 rpm	700 ... 3,200 rpm	400 ... 2,200 rpm	550 ... 1,350 rpm
Rated torque	270 ... 765 Nm	410 ... 790 Nm	490 ... 1,720 Nm	560 ... 1,650 Nm	1,230 ... 3,710 Nm	2,390 ... 12,415 Nm
Max. speed	7,500 rpm	3,800 rpm	6,000 rpm	3,500 rpm	3,300 rpm	2,800 rpm
Max. torque	920 ... 1,230 Nm	1,450 ... 1,950 Nm	1,760 ... 2,770 Nm	2,400 ... 4,000 Nm	3,500 ... 6,530 Nm	4,820 ... 23,600 Nm
Connection system	Terminal box, signal connection via connector					
Holding brake	Optional					
Insulation	Temperature class H (180 °C)					
Shaft design	Solid shaft with or without feather key					
Encoder system	Incremental encoder HTL, sin/cos Absolute encoder EnDat Built-on encoder (SIMOTICS M-1PH835.)					
DRIVE-CLiQ interface	Optional					
Converter system	SINAMICS S or SINAMICS G					

There's more to it

www.siemens.com/ids

Discover in detail
how integrated drive
systems boost your
competitive edge
and reduce your
time to profit.

For more on
integrated drive
systems, visit our
mobile website.



Follow us on:

www.twitter.com/siemensindustry

www.youtube.com/siemens

Siemens AG
Digital Factory Division
Motion Control
Postfach 31 80
91050 ERLANGEN
GERMANY

Subject to change without prior notice
Article No.: 6ZB5711-0AQ02-0BA4
V6.MKKATA.GMC.303 / Dispo 18401
BR 0616 1. SB/PES 10 EN
Printed in Germany
© Siemens AG 2016

The information provided in this brochure contains merely general descriptions or characteristics of performance which in case of actual use do not always apply as described or which may change as a result of further development of the products. An obligation to provide the respective characteristics shall only exist if expressly agreed in the terms of contract. Availability and technical specifications are subject to change without notice. All product designations may be trademarks or product names of Siemens AG or supplier companies whose use by third parties for their own purposes could violate the rights of the owners.